

BLAIR COUNTY

HUMAN SERVICES BLOCK GRANT

ANNUAL PLAN

FY 2018/2019



September 2018

Table of Contents

Appendix “A” Blair County Commissioners Assurance of Compliance	2
Appendix “A” Blair County Leadership Coalition Assurance of Compliance	3
Appendix “B” Blair County Human Services Plan	
<i>Part I: County Planning Process</i>	4
<i>Part II: Public Hearing Notice</i>	10
<i>Part III: Cross-Collaboration of Services</i>	23
<i>Part IV: Human Services Narrative</i>	
<i>Mental Health Services</i>	26
<i>Intellectual Disability Services</i>	52
<i>Homeless Assistance Services</i>	59
<i>Substance Use Disorder Services</i>	68
<i>Human Services Development Fund</i>	72
Appendix “C-1” Human Services Proposed Budget and Individuals to be Served.....	76
Appendix “D” UPMC Altoona Memorandum of Understanding.....	81

Appendix "A"

Blair County Commissioners Assurance of Compliance

Appendix A
Fiscal Year 2018-2019

COUNTY HUMAN SERVICES PLAN

ASSURANCE OF COMPLIANCE

COUNTY OF: Blair

- A. The county assures that services will be managed and delivered in accordance with the county Human Services Plan submitted herewith.
- B. The county assures, in compliance with Act 80, that the county Human Services Plan submitted herewith has been developed based upon the county officials' determination of county need, formulated after an opportunity for public comment in the county.
- C. The county and/or its providers assures that it will maintain the eligibility records and other records necessary to support the expenditure reports submitted to the Department of Human Services.
- D. The county hereby expressly, and as a condition precedent to the receipt of state and federal funds, assures that in compliance with Title VI of the Civil Rights Act of 1964; Section 504 of the Federal Rehabilitation Act of 1973; the Age Discrimination Act of 1975; and the Pennsylvania Human Relations Act of 1955, as amended; and 16 PA Code, Chapter 49 (Contract Compliance regulations):
 - 1. The county does not and will not discriminate against any person because of race, color, religious creed, ancestry, origin, age, sex, gender identity, sexual orientation, or disability in providing services or employment, or in its relationship with other providers; or in providing access to services and employment for individuals with disabilities.
 - 2. The county will comply with all regulations promulgated to enforce the statutory provisions against discrimination.

COUNTY COMMISSIONERS/COUNTY EXECUTIVE

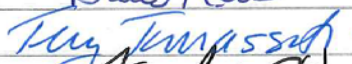
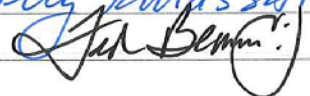
<i>Signatures</i>	<i>Please Print</i>	
	Bruce Erb	Date: <u>5/22/18</u>
	Terry Tomassetti	Date: <u>5/22/18</u>
	Ted Beam, Jr	Date: <u>5/22/18</u>

Appendix "A"

Blair County Leadership Coalition Assurance of Compliance

Appendix "A"
Fiscal Year 2018-2019

COUNTY HUMAN SERVICES PLAN
ASSURANCE OF COMPLIANCE

Blair County Leadership Coalition:

James Hudack, Executive Director
Blair County Department of Social Services

5/22/18
Date

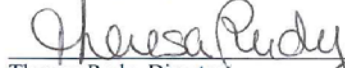
Theresa Rudy, Director
Blair County Mental Health Program

5/22/18
Date

Amy Marten-Shanafelt, Executive Director
Blair HealthChoices

5/18/2018
Date

Judy Rosser, Executive Director
Blair Drug & Alcohol Partnership

5/22/18
Date

James Henry, Executive Director
Southern Alleghenies Service Management Group

5/22/18
Date

Melissa Gordon, Intellectual Disability Director
Southern Alleghenies Service Management Group

5/22/18
Date

Kelly Popich, Early Intervention Director
Southern Alleghenies Service Management Group

5/22/18
Date

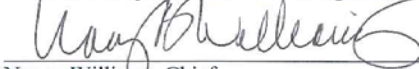
Nancy Williams, Chief
Blair County Juvenile Probation Officer

5/22/18
Date

Ashley Gehrdes, Executive Director
Blair County Children, Youth & Families

5/22/18
Date

Blair County Human Services Plan Fiscal Year 2018-2019

Part I: COUNTY PLANNING PROCESS

Blair County Background Information

Blair County's estimated 2017 census is 123,457 residents. This represents a 2.8% population decrease from 2010. As shown in *Table 1* below, a majority of the residents are between the ages of 18 and 64, and white. Transition aged youth (15 to 24 years of age) comprise 12.4% of the residents. Gender is split slightly high for females. Blair County's largest growing population is those 65 and over.

Age	
Under 18 years	20.1%
18 to 64 years	59.7%
65 and over	20.2%
Race	
White	95.8%
Black	1.8%
Two or more races	1.4%
Hispanic or Latino	1.2%
Asian	0.7%
American Indian or Alaska Native	0.2%
Gender	
Male	48.9%
Female	51.1%

Table 2 compares Blair County and the Commonwealth of Pennsylvania on various indicators.

Table 2. Indicators for Blair County compared to Pennsylvania, 2017		
	Blair County	Pennsylvania
Education		
High school graduation rate	90.7%	89.5%
Bachelor’s degree or higher	19.5%	29.3%
Income-related		
Unemployment rate (Jan. 2018)	4.3%	4.8%
Median household income	\$44,003	\$54,895
Poverty rate	13.6%	12.9%
Poverty rate for children under 18	21.8%	19%
Poverty rate for 65 and over	8.8%	8.1%
Public Assistance		
Receiving Medical Assistance	25.3%	22.5%
Receive food stamp assistance	19%	15%
Adults 65 and over that enrolled in PA prescription assistance program	4,503	277,679

As Table 2 details, Blair County has a slightly higher graduation rate than the state, but 10% fewer residents have completed four or more years of college. For income-related measures, the unemployment rate for Blair County is lower than for Pennsylvania, yet the median household income is \$10,892 less than the state, and poverty rates are moderately higher in Blair County when compared to the State. More people are receiving Medical Assistance in Blair County compared to the State; more people receive food stamps and more adults 65 and over receive prescription assistance.

According to the KIDS COUNT Data Center, the percentage of students who are enrolled in free/reduced school lunch programs in Blair County is 48.29% (2016/2017) as compared to Pennsylvania at 51.10%. Children living in families below 200% poverty is 40.6% (2016), compared to 39.6% (2015) and 38.1% statewide. The percentage of uninsured children under 18 years old in Blair County was 5.0% as compared to Pennsylvania at 5.3%. The percentage of children under age 18 with Medicaid coverage was 36.8%, compared to 30.2% in Pennsylvania. The percentage of unserved children eligible for publically funded Pre-K in Blair County is 48.7% which is lower than the State percentage of 65.8%, and significantly lower than the previous year at 58.5%.

Blair County ranks 45 out of 67 counties in Pennsylvania in overall health care according to County Health Ranking and Roadmap although the trend has improved over the last six years, this past year Blair County has improved two positions as compared to last year. Blair County residents demonstrate a very high morbidity ranking of 46 out of 67. This ranking, factors in overall poor health, poor physical days, and mental health days. Residents of Blair County also demonstrate a high level of risk behaviors such as smoking, obesity, and drinking as compared to other counties in the Commonwealth with a ranking of 48 out of 67. This was a significant decrease as compared to 2016 when Blair County was ranked at 62.

Blair County Health Rankings							
2011	2012	2013	2014	2015	2016	2017	2018
62	56	56	51	48	46	47	45

The cost of living in Blair County is 86.90 (less than the U.S. average at 100). The reason Blair County’s cost of living is lower is due to the lower cost of housing as compared to the rest of the nation. Yet, Blair County has a higher cost of living when comparing utilities, transportation, clothing and other services. The median price for a house in Blair County is \$110,600.00 as compared to Pennsylvania at \$166,000.00 and nationally the median price is \$178,600.00. From 2010 to 2015, Blair County had a decrease of over 700 housing units. These units lost were for the most part units available for low to moderate income individuals and families.

There are seven public school districts in Blair County: Altoona, Bellwood-Antis, Claysburg-Kimmel, Hollidaysburg, Spring Cove, Tyrone, and Williamsburg. The Greater Altoona Career and Technology Center offers vocational training to high school students from all seven Blair County Public School Districts. In addition to the public schools there are six Catholic elementary schools and one Catholic high school. Other schools are faith based schools such as Great Commission School and Blair County Christian School. FY 2016/2017 enrollment data for Blair County reflects 17,846 children enrolled in public schools and 1,422 enrolled in private schools.

Pennsylvania Department of Education data from 2009/2010 (most recent data available) indicates 220 children were enrolled in home schooling and 2015/2016 enrollment at Central Pennsylvania Digital Learning Foundation Charter School was 118 students. The County has three alternative schools operating to support children who have been expelled from their home school districts. Grier School, a private boarding school for girls in grades 7-12, is also located in northern Blair County. Two hundred ninety girls from 30 states and 16 foreign countries currently attend. 2015/2016 data reflects that all Blair County schools have a 1.42% drop out rate as compared to the state percentage of 1.67%.

The Pennsylvania State University (Penn State) Altoona Campus contributes to an influx of over 4,104 college students; and the campus is only 45 miles from the University’s main campus, University Park, in State College. Post-secondary trade/technical schools include Altoona Beauty School, Altoona Bible Institute, Pruonto’s Hair Design Institute, South Hills School of Business and Technology, and YTI Career Institute. Within a half hour of Blair County, other post-secondary schools include Mount Aloysius College, St. Francis University and Juniata College.

In January 2012, Blair County developed the Blair County Cross Systems Leadership Coalition to meet the requirements of Act 80, which established a Human Services Block Grant (HSBG) Program. Coalition members include County Commissioners, the Mental Health/Intellectual Disabilities/Early Intervention Administrator, the Chief Juvenile Probation Officer, Mental Health Director, Children, Youth, and Families Director, Human Services Office Director, and Executive Directors of the following organizations: Southern Alleghenies Service Management Group (SASMG) (Executive Director), Blair HealthChoices, and the Blair County Drug and Alcohol Partnership. In 2015, we also added to the Coalition the Intellectual Disabilities Director and the Early Intervention Director and the County Administrator. The coalition’s mission is to create a structure and build partnerships to collaboratively manage cross systems strategies that positively affect people. This Coalition meets monthly to review management and outcomes of the Block Grant Funds and the programs being supported with these Funds, and discuss any continuous issues and emerging trends. The Coalition reviews the progress made through the strategic plan, and helps prioritize next steps to better serve the residents of Blair County.

The Leadership Coalition developed a strategic plan based on prioritization of needs identified by the Coalition, additional stakeholders, and consumers of services. The priorities/needs identified were housing, transportation, employment, life skills, and the collection of data that allows for better informed decision making. These priorities have not changed over the past few years.

- *Attachment A (page 9)* outlines the stakeholder committee structure that includes individuals that receive services, families of service recipients, providers, and other system partners. These committees are held monthly, bimonthly, but not less than quarterly. Information and feedback shared by individuals that receive services, families of service recipients, providers, and other system partners' flows up and is reviewed within each system's planning process. It also flows up to the Leadership Coalition where recommendations are made to the County Commissioners. The planning and implementing of such recommendations is reported back to the individuals that receive services, families of service recipients, providers, and other system partners for ongoing feedback. This is an ongoing process that provides continuous opportunity for participation in the planning process.

In FY 2016/2017, the Blair County Cross Systems Leadership Coalition partnered with the Healthy Blair County Coalition (HBCC) to participate in the triennial county-wide needs assessment process, also utilized by our three area hospitals to meet requirements for the Affordable Care Act. The Steering Committee collaborates with a broader group of community stakeholders on whom the community decisions would have an impact, who had an interest in the effort, who represented diverse sectors of the community, and who were likely to be involved in developing and implementing strategies and activities. The Healthy Blair County Coalition is comprised of 128 community partners. They represent a diverse and valuable group of individuals and organizations which include the following: social services/charities, government, planning, public health, education, hospitals, community foundations, healthcare providers/behavioral health, businesses, economic development, criminal justice, libraries, drug and alcohol, health insurance/managed care, media, recreation, etc.

The HBCC survey was distributed to randomly selected households, businesses, associations, service providers, faith organizations, and key informants. The household survey was also administered to clients/consumers by seven other organizations in Blair County. In addition, secondary indicator data was collected and analyzed to track changes and trends over time for a given population. It is also useful as to whether research supports or does not support the perceptions of key informants and the general public as reflected in survey results. The 2015 needs assessment identified drug and alcohol issues, children's mental health, poverty, smoking and tobacco, workplace wellness and community wellness, and dental care as priority areas. Workgroups were formed to address each priority area, and Leadership Coalition members facilitate or participate in each workgroup. The results of the 2015 needs assessment are the same as identified in the 2012 and, in part, the 2007 needs assessments.

Funds from the HSBG have been used to partner with the three local hospitals and other providers for the planning and implementation of a community health needs assessment. The results of this information will supply a tremendous amount of data that can assist in the development of a strategic plan to better address the needs of the community in a variety of areas.

Currently, Healthy Blair County Coalition is in the process of conducting a new county-wide needs assessment. The results of this survey should be available in early 2019. Based on these results, a new strategic plan will be developed.

Blair County's Cross Systems Leadership Coalition works to assure that all of the residents of the County receive services in the least restrictive setting appropriate to their needs. Block Grant Funds are available to be shifted between categorical areas. The Leadership Coalition closely monitors how Block Grant Funds are used based on the Income & Expense (I&E) report. All decisions to realign the Funds are based on identified priorities/needs, as well as, outcomes or anticipated outcomes of those services funded through the Block Grant Funds. Any recommendations from the Leadership Coalition are submitted to the Blair County Board of Commissioners for final approval. How that shift in Funds is made is described below.

Through the strategic planning process, the Leadership Coalition, through stakeholder feedback, have identified the following priorities/needs; housing, transportation, employment, life skills, and data. The agreed upon standards are:

- Our decisions maximize resources to our community
- The management of resources are based on the values and priorities established in the annual plan (scope)
- Decisions (such as allocations, re-allocations, retained funds, etc.) are made in alignment with our priorities and values supported by objective data. Objective data measures the needs, capacity, efficiency, efficacy and outcomes of programs, services and projects
- Mandated services and target populations are defined and considered when making decisions

Our agreed upon values are:

- It is about the people we serve
- Respect the dignity of people
- Respect the discipline of each program and their constituents
- Provide quality services
- Empower and support people who receive services to create healthy interdependence, through natural supports and access to services

In addition we have identified the following operational values:

- Collaboration and team work
- Mutual trust and respect
- Honesty and integrity
- Creativity and innovation
- Action and productivity
- Quality of services/products

The funding changes that were made as a consequence of the concept of block granting resulted in the redistribution of funds to programs that identified critical unmet needs.

Blair County Stakeholder Involvement Flow Chart

Attachment A

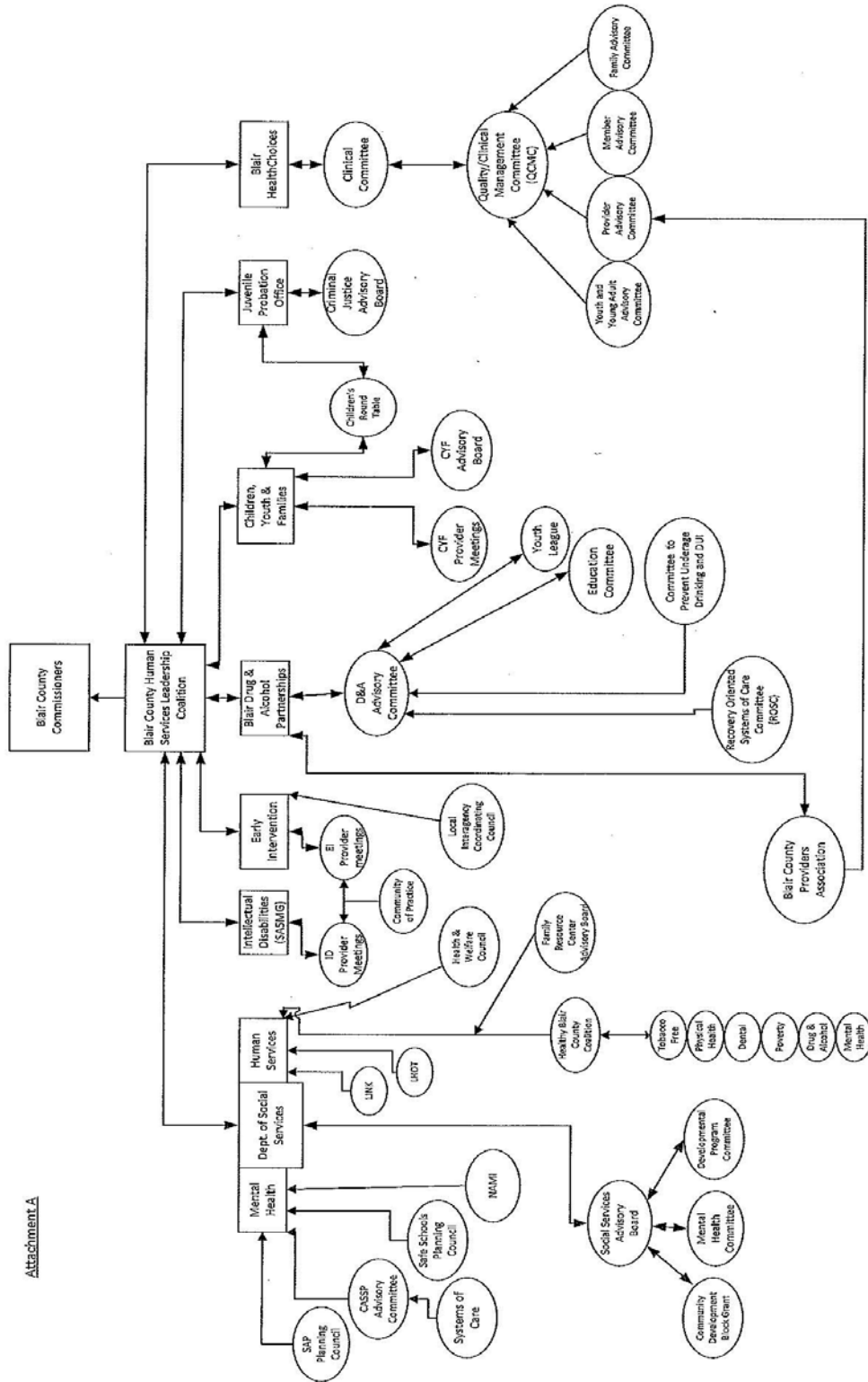

Attachment A

PART II: PUBLIC HEARING NOTICE

For the development of the FY 2018/2019 Human Services Annual Plan, Blair County conducted two Public Hearings to gain direct input from the community regarding priorities and issues that should be considered.

1st Public Hearing

On March 16, 2018, at 1:00p.m., the first Blair County Human Service Annual Plan Public Hearing was held at the Southern Alleghenies EMS Training Room located in Altoona. The location was selected due to the availability of being along public transportation routes and located in easy walking distance from a number of Blair County's largest providers and UPMC Altoona. This facility was also handicapped accessible. Both hearings were advertised in the Altoona Mirror, the major newspaper of Blair County. A flyer was also created and posted throughout the County of Blair. In addition, the flyer was emailed through a number of program list serves with the request to have the hearing notice disseminated to providers and individuals they serve. Individuals were also encouraged to submit written comments if they were unable to attend any of the meetings. An advertisement for the public hearing was published in the Altoona Mirror on March 14, 2018.

The first public hearing had 19 residents of Blair County in attendance. The intent of the first public hearing was to give an overview and process of the annual plan and to receive public comments and suggestions to be considered in the annual plan development.

NOTICE

"The Blair County Human Services Block Grant Annual Plan 1st Public Hearing for FY 2018-19 has been scheduled for Friday, March 16, 2018 at 1:00pm at the Southern Alleghenies EMS Training Room, 2900 Beale Ave, Suite 126, Altoona, PA 16601. If you are interested in submitting comments please E-mail the Blair County Department of Social Services at dss@blairco.org"

March 14, 2018

PROOF OF PUBLICATION OF NOTICE IN ALTOONA MIRROR

NOTICE
"The Blair County Human Services Block Grant Annual Plan 1st Public Hearing for FY 2018-19 has been scheduled for Friday, March 16, 2018 at 1:00pm at the Southern Alleghenies EMS Training Room, 2900 Beale Ave, Suite 126, Altoona, PA 16601. If you are interested in submitting comments please E-mail the Blair County Department of Social Services at dss@blairco.org"
March 14, 2018

**STATE OF PENNSYLVANIA
COUNTY OF BLAIR**

Ray Eckenrode, being duly sworn says: That he is the General Manager of the ALTOONA MIRROR, a newspaper of general circulation, published at Number 301 Cayuga Avenue, Township of Logan, City of Altoona, County of Blair, and State of Pennsylvania.

That said newspaper was established as a daily newspaper of general circulation on the Thirteenth Day of June 1874, since which date said newspaper has been published daily in the City of Altoona; that a copy of the printed notice, hereto attached, is exactly as the same was printed and published in the regular edition of the daily ALTOONA MIRROR published on the following date(s), viz:

March 14, 2018

The affiant further deposes and declares that he is not interested in the subject matter of the aforesaid notice of publication and that all allegations in the foregoing statement as to time, place and character of publication are true.

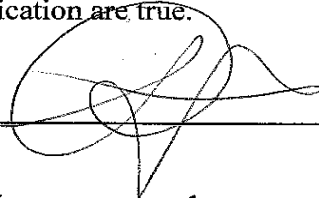

Sworn to and subscribed before me the 14 day of March, 2018.

Debra D. Miller, Notary Public

My Commission expires

Commonwealth of Pennsylvania
Notarial Seal
DEBRA D MILLER, Notary Public
ALTOONA CITY, BLAIR COUNTY
My Commission Expires July 25, 2021



BLAIR COUNTY HUMAN SERVICES 2018-19 ANNUAL PLAN 1ST PUBLIC HEARING NOTICE

Blair County is beginning the process of developing the 2018-19 Human Services Block Grant Annual Plan. The Human Services Annual Plan must be submitted to the Department of Human Services by the beginning of May, 2018. The 1st Public Hearing will be held at the following location to solicit public comment on the Human Services Block Grant Annual Plan.



Friday, March 16, 2018 at 1:00 p.m.
Southern Alleghenies EMS
Training Room
2900 Beale Avenue, Suite 126
Altoona, PA 16601

We want to hear from the community about their views of human services in Blair County. This would include: mental health, intellectual disability, children services, drug and alcohol, housing and early intervention services. We want people to share their personal stories. All individuals who utilize services and supports and all providers of services within the community are welcome and encouraged to attend. Please share your thoughts, opinions, stories, satisfaction and dissatisfaction, and ideas in helping us develop a plan that will benefit the citizens of Blair County.

If you are interested in submitting comments, please
E-mail the Department of Social Services at
dss@blairco.org



**PUBLIC HEARING
FOR
BLAIR COUNTY HUMAN SERVICE'S ANNUAL PLAN
FOR FISCAL YEAR 2018/2019
Friday, March 16, 2018
AGENDA**

1. Welcome and Introduction of Presenters – Jim Hudack, Blair County Department of Social Services, Executive Director
2. PowerPoint Overview of Human Service's Annual Plan – Jim Hudack
3. Introduction of Front Table:
 - Intellectual Disability Services Plan – Jamie Henry, Executive Director of Southern Alleghenies Services Management Group
 - Human Services Development Fund, Human Services and Supports and Homeless Assistance Plans – Cathy Crum, Blair County Human Services Director
 - Drug and Alcohol Services Plan – Judy Rosser, Executive Director for Blair Drug and Alcohol Partnership
 - Mental Health Services Plan – Theresa Rudy, Blair County Mental Health Director
4. Questions and Comments from Audience
5. Next Steps and Public Hearing Friday, May 11th, 1 PM at the Altoona Water Authority, 900 Chestnut Ave., Altoona



Commissioners
Bruce Erb, President
Terry Tomassetti, Vice-President
Ted Beam, Jr., Secretary

Blair County
Department of Social Services
423 Allegheny Street, Suite 441B, Hollidaysburg, PA 16648-2022
(814) 693-3023 • FAX (814) 693-3052
Web www.dss.blairco.org Email: dss@blairco.org

JAMES HUDACK
Executive Director
THERESA RUDY
MH Program Director
KENNETH DEAN
MH Program Specialist
CATHY CRUM
HS Program Director
CINDY JAMES
CASSP Coordinator
JACKIE SAYLOR
Fiscal Officer
LINDSAY DEMPSIE
Fiscal Specialist
TRINA ILLIG
Grants Coordinator for
Community Development
MELANIE BOLAND
Community Development
Specialist
MELISSA GILLIN
Administrative Assistant

The Blair County Department of Social Services
Human Services 2018-2019 Annual Plan 1st Public Hearing
Friday, March 16, 2018 at 1:00 p.m.
Southern Alleghenies EMS, Beale Ave, Altoona PA

MINUTES

Welcome and Call to Order

James Hudack, Executive Director of Blair County Department of Social Services, welcomed everyone and called the public hearing to order. Jim introduced himself and gave an overview of the purpose of the Public Hearing and what he hopes to achieve by listening and engaging the people of Blair County to participate in putting together the Annual Plan.

Jim Hudack also asked the Leadership Panel to do self introductions. The Panel consisted of Cathy Crum, Theresa Rudy, Jamie Henry, and Judy Rosser.

Jim went over a power point presentation that described the process of submitting the Annual Plan, the Timeline and that it is a requirement by the PA Dept. of Human Services. The tentative submission date is May 2018. Jim also reviewed some of the accomplishments from FY 2017-2018.

Public Comments/Input

Amber Brick, Kids First and member of the policy council for the Head Start program, expressed concern of the lack of affordable housing she has been seeing with the head start children. Many of the children and their families are living with friends or relatives due to lack of affordable housing. It is difficult to connect people with affordable housing. Rent is astronomical and families cannot afford \$700+ per month plus utilities. Some of the families need a temporary placement and others cannot afford the rent with their social security income.

Lisa Hann, Family Services, Inc., commended Cathy Crum on her retirement as Blair County Human Services Director and for the years of HSDF funding support to Family Services.

Nicole Germaux, CONTACT Altoona, expressed concern on gaps with coordinated entry. Those individuals leaving prison or half-way houses are homeless but not "homeless" according to the HUD standards. CONTACT Altoona has not been able to help the individuals.

Charles Lansberry, Skills, reported that there are drug & alcohol issues with individuals maintaining their employment. Charles stated Skills has been able to secure jobs for individuals through the employment service but once an individual receives their first paycheck, they go back to using, disappear and it is difficult to track them down.

Judy Rosser spoke about the opioid epidemic in Blair County and the Warm Hand off Program that is in effect in all 3 hospitals in Blair County.

Jim thanked everyone for attending.

The 2nd Public Hearing is tentatively scheduled for Friday April 6, 2018 at the Southern Alleghenies EMS, Beale Ave, Altoona, 1:00pm – 2:00pm.

HUMAN SERVICES ANNUAL PLAN/BLK Grant FY 2018/19

1st PUBLIC HEARING

March 16, 2018 @ 1:00PM

Southern Alleghenies EMS Training Room, 2900 Beale Ave, ALTOONA

SIGN IN SHEET

NAME	EMAIL	AGENCY	MUNICIPALITY
1. Kenneth Dear	Kolcom@Harris.org	Blair County	Blair
2. Jim Hudock	jhudock@blairco.org	Blair Co. Social Services	
3. Amber Brick	abruck@kidsfirstblair.org	Kids First	Blair
4. Cathy Connor	cconnor@blairco.org	Social Services	Logan Township
5. Charles Conroy	cconroy@skillsgroup.org	SKILLS	"
6. Diana Paebich	dpaebich@homerunagency.com	HNA	
7. Theresa Rudy	trudy@blairco.org	Blair DSS	
8. Melissa Godwin	Mgodwin@sasmg.org	SASMG	Blair
9. Kathy Custren	Kcustren@yahoo.com	NAMI	Blair Co.
10. Nicole Bernaux	nbernaux@ContractAltoona.com	Contract Altoona	
11. Lisa Hann	Lhann@familyresourcesinc.com	Family Services Inc	Blair
12. Cathy M Fee	cmcftee@skillsgroup.org	SKILLS	Blair
13. Judy Raper	jrapera@blairco.org	BDAY	Blair
14. M. A. Clark	chaftmj@upmc.edu	UPMC	Blair
15. Sandy Arnold	sarnold@northstars.org	NSS, Inc	Blair
16. Lindsay Wagner	Lwagner@BlairHealthChoices.org	Blair Health Choices	Blair
17. Jennifer Stubbs	JStubbsjmc@ccbh.com	Community Care	
18. June Hann	jhanney@sasmg.org	SASMG	Blair
19. Melissa Gillin	mgillin@blairco.org	Social Services	
20.			
21.			
22.			
23.			
24.			
25.			
26.			
27.			
28.			
29.			
30.			
31.			
32.			

2nd Public Hearing

The second hearing was held on May 11, 2018, at 1:00p.m. at the Altoona Water Authority, 900 Chestnut Ave., Altoona, PA.

The second Blair County Human Service Annual Plan Public Hearing conducted on May 11, 2018 had 17 residents of Blair County in attendance. During this hearing each program director gave a brief overview of their respective section of the annual plan. The audience had the opportunity to ask questions and make comments throughout the duration of the public hearing. The hearing was the final opportunity for any additional comments or suggestions. These comments were reviewed by the Blair County Leadership Coalition to be included in the final submission of the annual plan which was approved by the Blair County Commissioners on May 22, 2018. An advertisement for the public hearing was published in the Altoona Mirror on May 9, 2018.

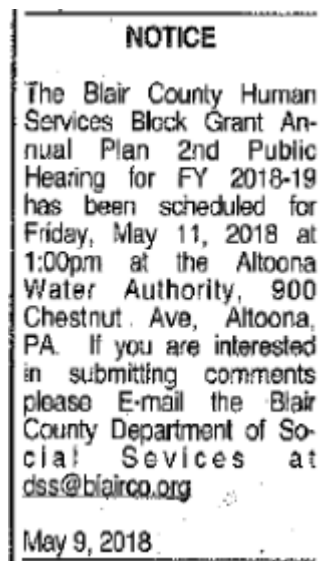

PROOF OF PUBLICATION OF NOTICE IN ALTOONA MIRROR

NOTICE
The Blair County Human Services Block Grant Annual Plan 2nd Public Hearing for FY 2018-19 has been scheduled for Friday, May 11, 2018 at 1:00pm at the Altoona Water Authority, 900 Chestnut Ave, Altoona, PA. If you are interested in submitting comments please E-mail the Blair County Department of Social Services at dss@blairco.org
May 9, 2018

**STATE OF PENNSYLVANIA
COUNTY OF BLAIR**

Ray Eckenrode, being duly sworn says: That he is the General Manager of the ALTOONA MIRROR, a newspaper of general circulation, published at Number 301 Cayuga Avenue, Township of Logan, City of Altoona, County of Blair, and State of Pennsylvania.

That said newspaper was established as a daily newspaper of general circulation on the Thirteenth Day of June 1874, since which date said newspaper has been published daily in the City of Altoona; that a copy of the printed notice, hereto attached, is exactly as the same was printed and published in the regular edition of the daily ALTOONA MIRROR published on the following date(s), viz:

May 9, 2018

The affiant further deposes and declares that he is not interested in the subject matter of the aforesaid notice of publication and that all allegations in the foregoing statement as to time, place and character of publication are true.

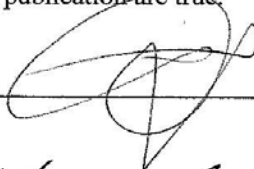

Sworn to and subscribed before me the 14 day of May, 20 18.

Debra D. Miller, Notary Public

My Commission expires

Commonwealth of Pennsylvania
Notarial Seal
DEBRA D MILLER, Notary Public
ALTOONA CITY, BLAIR COUNTY
My Commission Expires July 25, 2021

Blair County Office of Social Services

**Human Services
Annual Plan**

**2nd Public Hearing
for FY2018-2019**

Friday, May 11, 2018

**Altoona Water Authority
900 Chestnut Avenue
Altoona, PA**

1:00 PM – 3:00 PM

We want to hear from community members regarding their views of the human services annual plan for Blair County. This would include: mental health, intellectual disability, children services, drug and alcohol, housing and early intervention services. All individuals who utilize services and supports and all providers of services within the community are welcome and encouraged to attend. Please share your thoughts, opinions, and ideas in helping finalize the annual plan that will benefit the citizens of Blair County.

If you are unable to attend and interested in submitting comments, please E-mail the Blair County Department of Social Services at dss@blairco.org



**2nd PUBLIC HEARING
FOR
BLAIR COUNTY HUMAN SERVICE'S ANNUAL PLAN
FOR FISCAL YEAR 2018/2019
Friday, May 11, 2018
AGENDA**

1. Welcome and Introduction of Presenters – Jim Hudack, Blair County Department of Social Services, Executive Director
2. Overview of Human Service's Annual Plan – Jim Hudack
3. Intellectual Disability Services Plan – Jamie Henry, Executive Director of Southern Alleghenies Services Management Group
4. Human Services Development Fund, Human Services and Supports and Homeless Assistance Plans – Jim Hudack
5. Drug and Alcohol Services Plan – Judy Rosser, Executive Director for Blair Drug and Alcohol Partnership
6. Mental Health Services Plan – Theresa Rudy, Mental Health Director for Blair County Department of Social Services
7. Questions and Comments



Commissioners
Bruce Erb, President
Terry Tomassetti, Vice-President
Ted Beam, Jr., Secretary

Blair County
Department of Social Services
423 Allegheny Street, Suite 441B, Hollidaysburg, PA 16648-2022
(814) 693-3023 • FAX (814) 693-3052
Web www.dss.blairco.org Email: dss@blairco.org

JAMES HUDACK
Executive Director
THERESA RUDY
MH Program Director
KENNETH DEAN
MH Program Specialist
CATHY CRUM
HS Program Director
CINDY JAMES
CASSP Coordinator
JACKIE SAYLOR
Fiscal Officer
LINDSAY DEMPSIE
Fiscal Specialist
TRINA ILLIG
Grants Coordinator for
Community Development
MELANIE BOLAND
Community Development
Specialist
MELISSA GILLIN
Administrative Assistant

The Blair County Department of Social Services
Human Services 2018-2019 Annual Plan 2nd Public Hearing
Friday, May 11, 2018 at 1:00 p.m.
Altoona Water Authority, Chestnut Ave, Altoona PA

MINUTES

Welcome and Call to Order

James Hudack, Executive Director of Blair County Department of Social Services, welcomed everyone and called the public hearing to order. Jim introduced himself and gave an overview of the purpose of the 2nd Public Hearing for the Annual Plan.

Jim Hudack also asked the Leadership Panel for self introductions. The Panel consisted of Theresa Rudy, Jamie Henry, and Judy Rosser.

Jamie Henry gave an overview of the Intellectual Disabilities plan for FY 18/19. He shared the 3 objectives that are being focused on which include Person Center Focus, Employment and Life Sharing. Jamie also shared that there are now four agencies available to provide service coordination in Blair County.

Jim Hudack provided an overview of the Homeless Assistance Services and Human Services Development Fund plan for FY 18/19.

Judy Rosser reported on the Substance Use Disorder Services plan for FY 18/19. A large focus will be on the opioid crisis.

Theresa Rudy provided an update on the Mental Health Services planned for FY 18/19. Theresa reported that we continue to try to serve as many individuals as possible using the same funding allocation for the past several years.

Public Comments/Input

Crystal Walton asked if there were any plans to expand additional transportation services for medical appointments.

A question was asked if there were training classes available regarding the administering the Narcan for drug overdoses. Judy Rosser replied that there are classes held twice a month. They dates and times are posted in the Altoona Mirror Community page, the Rise for Recovery and Blair Drug and Alcohol Facebook pages. Judy reported that you will still need to complete the online State requirement as well.

A copy of the Annual Plan will be posted in the Department of Social Services section on the County website once the HSBG Plan is approved.

Jim thanked everyone for attending.

**HUMAN SERVICES ANNUAL PLAN/BLK Grant FY 2018/19
2nd PUBLIC HEARING**

**May 11, 2018 @ 1:00PM
Altoona Water Authority, 900 Chestnut Ave, ALTOONA**

SIGN IN SHEET

NAME	EMAIL	AGENCY	MUNICIPALITY
1. Jim Hudlock	j.hudlock@blairco.org	Social Services	
2. Theresa Rudy	trudya@blairco.org	Social Services	
3. Kenneth Olay	K.Olay@blairco.org	Social Services	Frank's Town
4. Audrey Orlt			
5. Melissa Diller		Social Services	
6. Katie Clauss	kelauss@homenursingagency.com	HNA	Altoona
7. C COHN	COHN53@YANAO.COM	T.I.R.T./CPAC	ALLEGHENY
8. Darrell Shildt	dshildt@hotmail.com	CPACC / TIRT	Altoona
9. Lindsay Wagner	lwagner@BlairHealthChoices.org	Blair Health Choices	
10. Dan Hooper	DHooper@HomeNursingAgency.com	HNA	Altoona
11. Shane Hodson	shodson@primary-health.net	PAN	Altoona
12. Gretchen Glatfelter	washingtoncaps4me@gmail.com	-	Altoona
13. Crystal Walton	cwcWalton@gmail.com	Nami, MNA, Hope	ALTOONA
14. Kelly Williams	Kwilliams@homenursingagency.com	HNA	Altoona
15. Melissa Gordon	mgordon@sasmg.org	SASMG	Altoona
16. Jim Henry	jhenry@sasmg.org	sasmg	Altoona
17. Pauline	clausb@skillsgroup.org	SHHS	Altoona
18.			
19.			
20.			
21.			
22.			
23.			
24.			
25.			
26.			
27.			
28.			
29.			
30.			
31.			
32.			

PART III: CROSS-COLLABORATION OF SERVICES

During the FY 2017/2018, Blair County was able to address the needs of its residents concerning housing, transportation and employment. A working group has been meeting over the past two years in developing a plan to create a new homeless shelter that will be able to accommodate more individuals. The current homeless shelter only has the capacity of 16 beds. On an annual basis, the current homeless shelter turns away over 500 individuals who meet the criteria, but the shelter is already at capacity. Based on the additional need identified, it is our intent to identify a new facility that can accommodate 40 to 50 individuals. This year has been rather challenging. We were able to identify 2 options for a new shelter, develop a business plan, identify additional stakeholders and began the design and needs of the shelter. Each of these options fell through for one reason or another. Fortunately, a new option has become available and seems to be looking more promising. This has also given us more time to enhance our relationships with other stakeholders and explore other funding sources. It is our intent to secure a property during this 2018/2019 year and begin securing the necessary funding and the renovations with the blending of both public and private resources.

In April 2015, a Housing Summit was held using HSBG funds to engage stakeholders in a conversation around special needs for housing in Blair County. From the ideas generated, the Blair County Housing Steering Committee was established to develop a strategic plan and meets quarterly to address the continuum of housing. Based on the established strategic goals, the following objectives have been achieved to date: the implementation of a Prepared Renters Program (PREP) for individuals to learn how to be better tenants, the development of a resource guide for both landlords and tenants in conjunction with the Landlords Association, the development of more comprehensive and sustainable housing plans for individuals released from jail, and a partnership with the Local Housing Option Team (LHOT) to create additional opportunities for affordable housing and address specific issues concerning different populations and their respective needs. To date, over 60 individuals have become trainers for the PREP curriculum, including CYF workers, correction officers, case managers, members of Clubhouse, librarians, and other advocates. By the end of FY 2017/2018, all Blair County probation officers will be trained in PREP. Another small group is currently working with a developer to create a number of new housing units that will have at least half the units being able to serve those with physical disabilities. The Steering Committee was instrumental in identifying housing needs and opportunities for Blair County's HealthChoices reinvestment plan, including temporary housing, permanent housing, and homeless prevention funds. Finally, we are working on ways to leverage additional funding through various sources both public and private to support the housing continuum in Blair County.

Our transportation program, established in March 2015, was able to receive a continuation of funds in FY 2017/2018. This program offers transportation services to individuals employed or have scheduled interviews with employers outside the current public transit system's service area and to individuals working within the public transit system's area but outside of its normal hours of operations. This program provides the service at no charge for the first 60 days. The next 90 days the rider pays a small service fee. Through March of 2018, 125 individuals sought the use of transportation services. Fifty-eight (58) individuals enrolled in the service and 5,110 trips were made. 30% of individuals had a mental health and/or drug and alcohol diagnosis, 16% were veterans, 19% were living in temporary or transitional housing, and 43% were on probation or parole. This year, the average trip was 7.20 miles, at a cost of \$2.01 per mile compared to last year where the average cost was \$2.22 per mile. 71.25% of the riders work between 3pm and 7am, and 38.39% work outside of the Altoona area, places and times of the day when public transportation is not available. In FY 2016/2017, 25-30% of the riders were contributing to the transportation service, but over 75% are now contributing totaling \$7,596 through March. When riders were surveyed, 100% felt the service was helpful and assisted them in maintaining employment.

The transportation program continues to be a challenge to develop a model that is the most cost efficient, stable, and produces the best outcomes. The Leadership Coalition continues to work closely with the provider to monitor outcomes and ways to maximize the transportation service to achieve the lowest cost with the most optimal outcome.

Since January of 2017, a small group of the Leadership Coalition, as well as, Judges, prison leadership, and adult probation leadership have been meeting to identify ways to address the mental health issues of inmates. On average, 65% of the inmates at Blair County Prison have a mental health diagnosis, with 10% having a serious mental illness diagnosis. The group has been using the Stepping Up Initiative framework, and officially signed on as a Stepping Up County on December 19, 2017. One of the group's major accomplishments in the past year was hiring a Mental Health Forensic Case Manager (MHFCM). After analyzing the process flow between arrest, incarceration, and release, it was determined that most often inmates were released without a good plan to reconnect to mental health services in the community, often resulting in re-incarceration. Community-based mental health providers were accommodating the inmates within seven days of release, but the process as it existed did not allow appropriate coordination to occur. The MHFCM is primarily responsible for coordinating mental health services upon an inmates' release. The MHFCM is employed with Blair HealthChoices, the entity that manages medical assistance for behavioral health, and is funded through the Human Services Block Grant. This allows for better coordination of services for Blair HealthChoices high risk members that end up incarcerated.

As part of the Stepping Up Initiative, the group has also been working together to increase accessibility to mobile crisis services. Through process mapping, the group also recognized the lack of consistent accessibility to mobile crisis services that would be able to assist in a mental health crisis. When asked, officers stated they would likely not arrest individuals in a mental health crisis if other options were available to them at the time. Using Human Services Block Grant Funds, and HealthChoices reinvestment funds, the crisis provider was able to purchase vehicles and other equipment needed, hire dedicated mobile crisis workers, receive crisis training, and increase marketing to the public. Although no outcomes data is available at this time, the community's response to the increased availability has been appreciative.

Another opportunity for cross-system collaboration has occurred with a group of consumers operating a drop in center. The drop in center is currently open once a week through the lunch hour. It gives consumers the opportunity to connect with their peers and support each other in their recovery. The Human Services Block Grant has supported their growth by providing funds for one paid position and additional funds to support the operations of the program. The Leadership Coalition continues to partner with H.O.P.E. Drop in to strategically plan their expansion. In turn, H.O.P.E. Drop In plays a key role in Human Services Block Grant planning. They are active participants at the Human Services Block Grant public hearings and through the Community Support Program (CSP). They also participate in many other community outreach activities to increase awareness and reduce the stigma of behavioral health.

Blended funding was awarded to support individuals with a Dual Diagnosis. These funds went to cover additional expenses for programs and services that are funded out of Base Intellectual Disabilities funds. Blair County's Administrative Entity agency developed the position of a Mental Health/Intellectual Disabilities (MH/ID) Navigator. This position supports individuals with have a dual diagnosis and works to better coordinate services between the program areas of Intellectual Disabilities and Mental Health. So far this year, this position has worked with 10 teams to provide additional support and assistance to the team members. This position also is responsible for our Technical Assistance Support Team (TAST) that reviews complex cases and offers suggestions and advice to the individual's team. Since July 1, 2017, TAST has reviewed 25 cases. Finally, the Navigator is the main contact person for any referral for the Dual Diagnosis Treatment Team (DDTT) and the Community Stabilization and Reintegration Unit (CSRU).

Through HSBG funding a transition age summer employment program has been offered for the past four years. The first two years an average of 10 students who have an ID diagnosis received summer work experience just as many teenagers do. The intent of the program is to demonstrate to the students and their families that the students can work, be safe, and be successful outside of a segregated setting. The program is designed as a grant proposal. Each proposal is capped at \$10,000. Organizations can apply to offer work experience to any number of students in the program, and can design those experiences tailored to the students' needs and interests. Examples from previous grants range from traditional job placement with coaching, to the development of a micro enterprise with profit sharing for the students. This past year, the grant employment program was expanded to include a total 25 students. This year we again will be offering the same level of funding as in FY 2016/2017 with the goal of serving 25 to 35 individuals.

Since 2012, Blair County has been conducting Mental Health First Aid classes to the residents of the county through Blair County NAMI. Over time a number of the certified instructors have relocated or no longer have their instructor certifications. In order to continue to operate this program there is a need to conduct a new certification course through the National Council for Behavioral Health. These funds were matched with additional funds to lower the costs for participants. There were 28 individuals who received their Adult Mental Health First Aid certification. These MHFA certified individuals are required to offer 3 classes per year to maintain their respective certification.

All categoricals will be funded for FY 2018/2019.

PART IV: HUMAN SERVICES NARRATIVE

Mental Health Services

a) Program Highlights:

HSBG Fiscal Years (FY) 2013/14 – 2017/18

The County Mental Health Program has benefitted from the use of block grant retention funds to start up several new programs including the Peerstar LLC Citizenship Group (2015/16), the Dual Diagnosis Navigator (2015/16), the MH Forensic Case Manager (2017/18), and Mental Health First Aide (MHFA) (2017/18).

In FY 2018/19, \$105,000 from the HSBG MH funding amount required to continue the Citizenship Group, DD Navigator, and MH Forensic Case Manager.

Peerstar LLC Citizenship Group

Peerstar Citizenship Group sessions were piloted at the Blair County Prison beginning March 2016 with 22 individuals served in FY 2015/16. In FY 2016/17 fifty-one (51) participated and in the current FY fifty-five (55) through March 2018. Forensic trained and Citizenship Facilitator trained Certified Peer Specialists co-facilitate the Yale University-based Citizenship Group classes for pre-release training and preparation. The curriculum covers topics that range from *processing emotions* and *communication skills* to *problem-solving* the logistics of *re-entry* into the community. The program targets participants' isolation and lack of valued social roles and skills for successful community living. Research using the citizenship framework has demonstrated its effectiveness in reducing participants' hospitalization days, substance use and increasing their quality of daily living. Groups occur twice a week for 2 hours each session with 2 facilitators. Each facilitator has one hour each week to allow individual time to orient/intake new members and/or meet with current members individually as needed. A complete cycle of the Citizenship Group is 20 sessions. County HSBG MH funds committed to sustaining this program in 2018/19 are \$10,000 budgeted in the OMHSAS cost center Transitional & Community Integration – Forensic Services.

Dual Diagnosis Navigator (MH/ID)

The Dual Diagnosis Navigator originally was a part-time position at the Blair County's Supports Coordination agency. This position supports individuals (primarily adults and some transition age youth) who have a dual diagnosis and works to better coordinate services between the program areas of intellectual disabilities and mental health. Due to the success of this initiative, the Navigator was made a full time position and employed at Southern Alleghenies Service Management Group (SASMG) beginning in January 2017. County HSBG MH funds committed to sustaining this program in 2018/19 are \$30,000 budgeted in the OMHSAS cost center Administrative Office.

Mental Health Forensic Case Manager

The Mental Health Forensic Case Manager serves to assist inmates in gaining access to needed behavioral health, medical, social, educational, and other services. The service is responsible for assessing inmates' needs, discharge plan development, implementing and reviewing success of discharge plans, and working with other community resources in meeting inmates' mental health needs. This service may also support adults with a mental health diagnosis, who have court service involvement due to criminal charges in attempt to divert from incarceration.

This position is organized under the County's Stepping Up Initiative to increase connections to mental health treatment upon release from jail, to help reduce the length of time spent in jail, reduce recidivism, and respond to mental health crises appropriately and safely to reduce the number of people with mental illnesses booked into jail. This Initiative has full support of the Criminal Justice Advisory Board (CJAB) and the Commissioners in the County of Blair. The Mental

Health Forensic Case Manager will work closely with the departments represented at CJAB, including but not limited to the Judges, District Attorneys, Public Defenders, Adult Parole and Probation, Children and Youth, Juvenile Probation, Department of Social Services, and Blair HealthChoices. The Mental Health Forensic Case Manager will be an integral part in streamlining communication systems to improve the response to people with mental illness entering the legal system. Blair HealthChoices received a county contract effective 12/1/17 to employ the Forensic Case Manager. County HSBG MH funds/County Match committed to sustaining this contract in 2018/19 are \$65,000 budgeted in the OMHSAS cost center Transitional & Community Integration – Forensic Services.

Mental Health First Aid (MHFA)

MHFA is an international program that began in Australia in 2001 and the USA in 2007 and teaches how to identify, understand, and respond to signs of mental illness and substance abuse disorder in your community. MHFA is listed on the Substance Abuse and Mental Health Services Administration (SAMHSA) National Registry of Evidenced-Based Programs and Practices (NREPP). NAMI Blair County coordinates the 8 hour MHFA trainings and courses since 2012. The Intermediate Unit (IU) # 08 serving 4 counties provides Youth MHFA and held 3 courses last year and 2 courses in Blair and 1 course in Cambria during the summer 2017, with 1 course scheduled in Altoona in June 2018.

NAMI PA Blair County hosted a MHFA Train the Trainer event during the week of 10/23 through 10/27/17. The course was presented by the National Council for Behavioral Health. There were 28 facilitators who became certified to present the eight hour Adult MHFA program. \$10,000 HSBG retention from the prior FY were used to offset the training expenses for this training the trainer opportunity.

National Alliance on Mental Illness (NAMI) PA Blair County offers educational and support programs, and resource and referral help line. The Peer to Peer education program is ten 2 hour sessions offered to adults with mental illness who are looking to better understand their condition and journey to recovery. The Family to Family is two 2 hour session education program offering communication techniques, and empathetic understanding of the family member's perspective in the recovery process. In Our Own Voice is presented by individuals who have lived experience with mental illness. They share a comprehensive and interactive presentation about their own mental health experiences. The program offers insight into the hope and recovery possible for individuals living with a mental illness. In September 2017, NAMI participated with an In Our Own Voice Facilitator Training event, present by NAMI Keystone. Three additional individuals from Blair County became certified to present the In Our Own Voice program.

The NAMI Connection Support Group meets once per week for 1.5 hours and is an opportunity for individuals to talk to someone who understands and has been in the same situation to give hope and inspiration for their recovery. In June 2017, NAMI PA Blair County hosted a Connections Facilitator Train the Trainer event presented by NAMI Keystone. Three individuals from Blair County became certified to conduct the NAMI Connection Support Group. NAMI PA Blair County promotes education and fellowship at the H.O.P.E. Drop In once per month, and the Elements in Harmony Youth and Family Support at the Hollidaysburg Library twelve one hour sessions.

NAMI participated with the Ending the Silence Facilitator Training in August 2017. A parent and child team from Blair County became certified to present the Ending the Silence program. This 50 minute presentation is geared toward middle and high school age students and encourages youth to talk with someone about any mental health symptoms they are experiencing and how to seek help.

The annual Recovery Conference was held 4/20/17 "Find Your Voice" with 140 individuals attending and 20 agencies represented. The 2018 Recovery Conference was held 4/19/18.

Health, Opportunity, Purpose and Empowerment (H.O.P.E.) Drop In

H.O.P.E. Drop In began in 2015 and in FY 2016/17 received a county contract for this new mental health program with eighty-one (81) individuals participating. Sixty-one (61) individuals have participated through March 2017 this FY. A part-time Executive Director, who self-identifies as a consumer of mental health services oversees this social rehabilitation program currently open on Mondays 12 p.m. – 4 p.m. at the Bethany Lutheran Church in Altoona. There is an active steering committee working on a strategic plan to grow this program in the future. HSBG MH funds committed to this program in FY 2018/19 is \$30,000 and are budgeted in the OMHSAS cost center Social Rehabilitation.

May is Mental Health Month (MMHM)

Blair County has hosted an event each year during the month of May to promote mental health awareness and to reduce the stigma of mental illness. The 2017 Blair MMHM event “Life with a Mental Illness” was held on May 24th with 6 sessions of 8 different presentations focused on Post Traumatic Stress Disorder (PTSD), Depression, Bipolar Disorders, and the Lesbian/Gay/Bisexual/Transgender/Questioning/Intersex (LGBTQI) issues for example, discrimination in public accommodations, employment, housing, health, family interactions, interactions with criminal justice, violence/bullying.

The keynote presentation was given by Carolyn Donaldson, Community Engagement Manager at WPSU Penn State, with the kick off of the Healthy Blair County Coalition “Community Conversations about Mental Health” based on the federal Substance Abuse and Mental Health Services Administration (SAMHSA) community conversations toolkit. This toolkit contains briefs, guides, and other resources designed to help people promote mental health and access to treatment and recovery services within their communities.

The Health Blair County Coalition is hosting community conversations about mental health for the community to have a better understanding and be more supportive of mental health, especially for young people. Community conversations can be held at various locations and are planned for 90 minutes to two hours at a convenient day and time. To schedule an event, please call the Blair County Department of Social Services at 693-3023. Please reference the one page infogram of the mental health and drug and alcohol access points in Blair County, *on page 80* which includes many interesting statistics about us.

The 2018 Blair MMHM event was held on May 1st in Altoona.

b) Strengths and Needs:

- **Older Adults (ages 60 and above)**
 - **Strengths:**
 - Continue to add senior Housing options.
 - Contract with Blair Senior Services for Domiciliary Care, Guardianship and Power of Attorney
 - Assessing capacity as we prepare for Community HealthChoices in 2018
 - **Needs:**
 - Psychiatric expertise and Peer Support working with the aging population.
 - Geriatric addiction resources
 - Accessibility to Medicare behavioral health providers
- **Adults (ages 18 and above)**
 - **Strengths:**
 - Blair HealthChoices care management for high risk adults managing 10% of HealthChoices members

- Providing a curriculum of MH/ID trainings to increase competencies of behavioral health providers
- Increased capacity for targeted case management now operating as an integrated physical /behavioral health home
- Comprehensive continuum of MH services, including addition of Mobile Psychiatric Rehabilitation
- Revitalized the Blair County Community Support Plan (CSP) Committee in FY 2016/17 through technical assistance from the PA Mental Health Consumers Association (PMHCA) and provided the PMHCA Leadership in Recovery (LIR) training in Altoona. Meetings are held monthly generally the third Friday of the month at 1:00pm at the Altoona Water Authority in the conference room.
- Development of a Dual Diagnosis Treatment Team through HealthChoices reinvestment
- Lexington Clubhouse, expansion of services
- National Alliance for the Mentally Ill (NAMI) Blair County offers the NAMI Peer to Peer and Family to Family Education classes, NAMI Connection support group, and Annual Recovery Conference
- Dual Diagnosis (MH/ID) steering committee
- Drop In Center (s) continue to increase attendance
- Technical Assistance Support Team (TAST), multi-disciplinary team to support individuals with complex mental health and intellectual disabilities
- Navigator to support cross system coordination for individuals with mental health and intellectual disabilities
- Re-occurring May is Mental Health Month Event
- **Needs:**
 - Increase recovery oriented mental health services, shifting more toward recovery model
 - 24 hour supervised living arrangement Long Term Structured Residence (LTSR)
 - More personal care home opportunities for more individuals that have SSDI with personal care home supplement
 - Safe, decent, and affordable housing
 - Mobile support for Domiciliary Care
 - Transportation
 - Employment opportunities
 - Increase availability of mobile crisis
- **Transition-age Youth (ages 18-26)**
 - **Strengths:** Transition age youth are prioritized across all County systems. The MH Program Office recognizes the struggle making the shift from youth to young adulthood can be, and having a mental illness can add a unique dimension to this change. There are several services and activities that are available in Blair County to assist transition age youth. For example, targeted case management (TCM) works with youth as they transition into adulthood. The TCM staff assist with finding housing, exploring educational and vocational options, accessing clinical services and treatment, etc.

Transition age youth are also supported by the Blair County Transition Council. The purpose of the Blair County council is to enhance services & supports for persons with disabilities as they transition from school to post school activities & adult community living. The council meets monthly.

Other supports include drop-in centers and specialized support groups for transition aged youth with autism. The County has also implemented a Youth and Young Adult Advisory Committee and a System of Care team working on engaging this population.

- Active local Transition Council including ID and MH
- Targeted Case Management set up to work through transitional age
- Included in Drop In Center (s)
- Elements of Harmony is a transitional age youth with autism support group
- Implemented a Youth and Young Adult Advisory Committee
- Prioritized across all systems
- Started a System of Care Team working on youth engagement
- Implementation of SAMHSA's Community Conversations
- Implementing Peer Support Services for TAY
- **Needs:**
 - Local job training
 - Independent living skills development/housing
 - Smoother transition from child serving system to adult serving system
 - Individuals with Autism or ID transitioning out of Behavioral Health Rehabilitative Services (BHRS)
 - Autism Adult Waiver provider capacity
- **Children (under 18)**
 - **Strengths:**
 - Implementation of SAMHSA's Community Conversations
 - BHRS Consortium: transformation of services- i.e. clinical training, provider faculty, value-based contracting
 - School Collaborative Strategies initiative to improve relations between providers and schools, annual event followed by monthly meetings and the BHRS Consortium.
 - Suicide Prevention Task Force (SPTF) meets monthly, Aavidum
 - Established and trained on an updated Multi-Disciplinary Investigative Team (MDIT) including mental health care and a MDIT Coordinator
 - PCCD Grant to train 21 Licensed Therapists in Trauma Focused Cognitive Behavioral Therapy to provide services to children referred to the MDIT of future Blair County Child Advocacy Center.
 - Child/Adolescent Service System Program (CASSP) Advisory Committee
 - CASSP Blair County Learning Community PA System of Care Partnership
 - Student Assistance Program (SAP) including the SAP Coordination Team and SAP School District Council
 - Maintained and expanded Community and School Based Behavioral Health teams in Tyrone and Altoona Area School Districts, adding one additional elementary school in Altoona
 - HealthChoices comprehensive care management for children
 - Expanded Teen Shelter at new location
 - CASSP Team Meetings
 - Maintaining Evidenced Based Programs including Family Group Decision Making(FGDM), Multi-Systemic Therapy (MST), Functional Family Therapy (FFT), Parent Child Interaction Therapy (PCIT)

- Completed an RFP for specialized Residential Treatment for adolescent with high risk behaviors and adolescents with MH/ID.
- Implementing Peer Support Services for Youth 14 years and older
- **Needs:**
 - Co-Occurring Disorder (COD) adolescent treatment
 - Provider competency for aggressive children
 - Respite care-lack of adequate funds
 - Prevent adoption disruption
 - Children with multiple out of home placements coming up on age 18
 - Increased efforts and sustainability of anti-bullying programs
- ***Individuals Transitioning Out of State Hospitals***
 - **Strengths:** Participation on the individual's Community Support Plan (CSP) Team meetings always includes the Torrance State Hospital (TSH) team, Blair County Department of Social Services, Blair HealthChoices and/or Community Care Clinical Care Manager(s), the Home Nursing Agency (HNA) state hospital liaison, Contact Altoona peer mentor, and the meetings are facilitated and recorded by the Allegheny HealthChoices, Inc. (AHCI). The CSP document is a person-centered plan which includes services and residential preferences the individual has identified as vital to his/her recovery process to insure a successful transition from the state hospital into the community. There were 25 CSP meetings 7/1/16 – 7/31/17 resulting in 6 discharges from the state hospital. As a result of Pennsylvania's revision to the state Olmstead Plan guidelines in Fiscal Year (FY) 2016/17, Blair County Department of Social Services: Conducted a scan of the existing services and housing options available for people with mental illness; Met with key stakeholders to discuss gaps in the service system and housing inventory; Conducted an extensive review of previous planning efforts, documentation and data and developed a Plan that acknowledges successful integration efforts and maps out ways to address integration and community based services and supports. The OMHSAS sent letters to Counties 7/10/17 that the Olmstead Plans have been received and are considered final.
 - **Needs:**
 - Supervised housing
 - Transition to Partial Hospital Program (PHP) under-utilized
 - Enhanced/Specialized Personal Care Homes (PCH) DPW licensed for less than 16
 - Long Term Structured Residence
 - Mobile Treatment Teams: Community Treatment Team (CTT), Assertive Community Treatment (ACT)
 - DBT treatment
 - Crisis Diversion/Crisis Intervention Services: Residential
 - Extended Acute Care Hospital to reduce the need for state hospital admissions
- ***Co-occurring Mental Health/Substance Use Disorder***
 - **Strengths:** Blair County works with its partners in the service system to treat individuals of all ages with co-occurring mental health and substance use disorders. For example, Blair HealthChoices initiated Recovery Oriented Methadone (ROM) for people 18 years and older in July 2012 and has worked closely with Blair County Drug and Alcohol Partnerships to roll out the Recovery Oriented Systems of Care (ROSC) Initiative. Community Care has taken this initiative statewide with the ROSC Center for Excellence. Two Blair County providers are participating in this initiative.

Blair County also has very active specialty courts, including a criminal drug court, family drug court, juvenile drug court, and the Driving Under the Influence (DUI) court, which frequently places individuals into treatment instead of incarceration.

In addition, Blair County has also worked to provide the infrastructure and training staff need to better serve individuals with co-occurring disorders. For example, the County has used the Comprehensive Continuous Integrated System of Care (CCISC) model (Minkoff and Cline) since 2004. Since that time, co-occurring disorder development for all clinical and direct care staff has been offered through Pennsylvania Certification Board (PCB) approved training. The Blair County Change Agent Connection also facilitates the use of the Blair CCISC training curriculum and case studies to make the connection between competencies and clinical practice goals, and provides learning collaborative across all systems, and in the community.

- **Needs:**
 - Increase clinicians applying for the PCB CCDP credential
 - Easier way to dually license and monitor co-occurring competent programs
 - Increase capacity for detox, or outpatient detox programs

- ***Justice-involved Individuals***

- **Strengths:** There are several ways in which Blair County addresses the needs of both adults and juveniles with a mental illness who are also involved with the justice system.

For adults, a cross-disciplinary team meets for case discussions and planning for the most complex individuals referred by the criminal justice system, primarily Blair County Adult Parole Office (APO) and the Blair County Prison (BCP). Blair County also has very active specialty courts, including a criminal drug court, family drug court, juvenile drug court, and DUI court, which frequently places individuals into treatment instead of incarceration. Forensic Certified Peer Specialists provide support and services for people involved with the justice system. This peer-based service is a complement to treatment for behavioral health issues. Blair County established a Crisis Intervention Team (CIT) in collaboration with human service providers and law enforcement offices within the community. The CIT received a Pennsylvania Commission on Crime and Delinquency (PCCD) Grant to assist with training expenses. Blair HealthChoices' Care Management participates in the Assessment Team and complete mental health level of care assessments in the prison for those with complex needs. Upon release, a psychiatric appointment is available within seven days. Blair County MH worked with Blair County Prison, PrimeCare Medical, County Assistance Office, and the UPMC Access Center/Base Service Unit (BSU) to develop a process for individuals at their minimum sentence date to expedite MA enrollment and the following:

- Ten day supply of medication with prescription to cover until psychiatric medication management appointment
- Triage with the Access Center/BSU and arrange initial appointment at Primary Health Network (PHN)/Federally Qualified Health Center (FQHC)
- Referral for Targeted Case Management

Lastly, Blair County has been able to help support a pilot project established by Blair County Drug and Alcohol Partnerships, Inc. to provide Vivitrol to individuals incarcerated in the Blair County Jail. Inmates are offered Vivitrol, as well as support from a Certified Recovery Specialist who assists inmates

in developing a recovery plan. A plan is established for continued care upon release, including follow up visits to receive Vivitrol.

- **For Individuals with Criminal Justice/Juvenile Justice History**

- The Blair County court system also embraces the Permanency Practice Initiative (PPI) philosophy and promotes recommended practices. These practices include: Family Group Decision Making (FGDM), which Blair County makes available to any member of the community, regardless of agency involvement; Strength-Based Family Worker (SFW) credentialing program formerly known as Family Development Credentialing (FDC), allowing over 180+ community partners to become credentialed at no cost to participants over the past four years; Alternatives to Truancy, from which Blair County had developed a Truancy Court and other Positive School Attendance support group services, with Magisterial District Judge (MDJ) participation and support.

Blair County CYF, in conjunction with the JPO, members of the court and judicial system, provider agencies, mental health professionals, early childhood education and school district personnel, and other various entities who work with children and families on a daily basis have continued to meet regularly. The discussions have been held to find solutions for the ongoing community issues which present challenges and barriers to safety, permanency, and well-being.

One community issue, Trauma and Trauma-Informed Care, continues to rise to the forefront of need for the children and adolescents of Blair County. Our community is in need of additional and expanded opportunities for Trauma based care and therapy services. Blair County CYF, during the year of 2015/2016, began a trauma-informed certified Therapeutic Yoga Program (TYP) for those children in both traditional and kinship foster care situations. This also program served children through General Protective Services (GPS). Both the resource parent(s) and the biological parent(s) are invited to attend and participate in the TYP with the child. This program is expected to reduce the reliance of psychotropic medication and poor behaviors in the school, home, and community settings by teaching new relaxation, breathing, and self-centered skills through TYP. Finding alternative ways and fostering support to increase the use of Kinship care (subsidized and non-subsidized) is also under consideration and will receive more attention through a dedicated work group of Blair County professionals.

Blair County also has extensive services for children and youth with a mental illness who are involved in the juvenile justice system.

These services are the result of system-wide team, such as the collaboration within the Juvenile Protection Office (JPO) and Children, Youth, and Families (CYF) agencies; the county CASSP system; CYF's Provider Group meetings; the Clinical Based Outcomes Committee; Evidence Based Team meetings; and the Children's Roundtable effectively led and guided by Blair County's President Judge Jolene Kopriva in which both JPO and CYF are integral parts of the process.

Communication techniques and goal setting practices such as Motivational Interviewing (MI); Critical Thinking skills and techniques; and capitalizing on family and individual strength based successes are all crucial tools used to assure Safety, Permanency, and Well-being for the families of Blair County. All County workers, as well as community service providers, are strongly encouraged and supported to complete the Temple University curriculum led Strength Based Family Worker (SBFW) program which aids the worker in finding the positives and best scenarios for all families and individuals served in the community.

The Blair County CASSP Advisory Committee, comprised of representatives from numerous child service agencies and educational realms, has been instrumental with assistance for children, youth, and families experiencing difficulty within the system or who just have very specialized needs such as severe emotional disorders or other difficult mental health needs. Permanency Practice Initiatives, Truancy, Safe Schools Initiatives, and Suicide Prevention Initiatives are just a few examples of community needs that have been focused upon within the CASSP Advisory Committee.

Many therapeutic enhancement strategies, new procedures, and strengthened practices for prevention services have occurred during workgroup sessions and subcommittee level meetings, all for the benefit of children, youth, and families within Blair County. A myriad of nationally acclaimed, outcomes based, and statistically proven programs have been researched and discussed during one or more collaborative group meetings held by entities coming together for children, youth and families.

Multi-Systemic Therapy (MST) and Functional Family Therapy (FFT) are just a few examples of nationally recognized evidence based programs which have been offered in Blair County since as early as the year 2000, funded originally by grants through the Pennsylvania Commission on Crime and Delinquency (PCCD). These two programs were later added to the Special Grants funding proposal due to the research and evidence based proven outcomes, as well as the fiscal incentives to the county for utilization of these best practice methods. Both of these programs are viewed as preventative in nature and are now also funded through the Medical Assistance program for eligible children and youth, this is especially important for service delivery to those children not currently involved with CYF or JPO. These two services are also included in Blair County's continuum of care for BHRS.

- **Needs:**
 - Re-entry planning and support
 - Co-Occurring Disorder (MH/SA) treatment, prescription of services to be more individualized and based on stage of change for the individual, less is sometimes more
 - More comprehensive in-prison mental health services
 - Better coordination between APO and Medication Assisted Treatment Services Providers
- **Veterans:**
 - **Strengths:**
 - Veterans Committee, a sub-committee of the specialty courts system, exploring peer mentoring when veterans are in the court system
 - Local access to services
 - James Van Zandt VA Medical Center in Altoona has a Behavioral Health Clinic with competent clinicians
 - VA participates in LHOT, CJAB, Suicide Prevention Task Force, MHFA and CIT Training
 - **Needs:**
 - Limited coverage of MH providers for their family/children (Tricare)
 - Communication between VA services and non-VA services
 - Case Management Services

- ***Lesbian/Gay/Bisexual/Transgender/Questioning/Intersex (LGBTQI) Consumers***

- **Strengths:**

- Local LGBTQI training through Community Care
 - Therapy services are available
 - SAP groups targeted for LGBTQI
 - Support group at Penn State University (PSU) Altoona for community
 - BDAP offers continuing education credits/trainings that are valuable

- **Needs:**

- Support Groups for Adults
 - Increased cultural sensitivity and anti-bullying efforts
 - Increased training opportunities
 - Need to advertise services that are currently available

- ***Racial/Ethnic/Linguistic Minorities (including Limited English Proficiency)***

- **Strengths:**

- Assessment process is thorough
 - Bi-lingual care management (Spanish)
 - Written material in Spanish

- **Needs:**

- Not well advertised, accessible

- ***Other - Individuals with Both Behavioral Health and Physical Health Needs***

Blair County recognizes that most people served in the system have complex needs that require coordinated treatment, including mental health and physical health needs. Physical health symptoms can often mimic or exacerbate behavioral health symptoms and vice versa. Looking at each person holistically, means focusing on symptoms and illness, but also wellness and prevention.

To address the needs of this population, Blair County providers have participated in Community Care's Person-Centered Outcomes Research Institute (PCORI) grant, Behavioral Health Homes, and Chronic Special Needs Population (CSNP) projects to engage adults/adults with Medicare in various wellness approaches to stabilize mental health and physical health symptoms. Through Blair HealthChoices Comprehensive Care Management, the County has implemented a physical health/behavioral health coordination model for both adults and youth with complex needs.

Blair County also continues to be an active partner in initiatives established by the Healthy Blair County Coalition, based on priorities identified through the community needs assessment, including improving children's mental health, Screening Brief Intervention Referral and Treatment (SBIRT) for adults and adolescents, and healthy lifestyle behaviors.

- ***Other - Individuals Who are Deaf or Hearing Impaired***

PATH has the ability to provide sign language interpreters so that adolescents who are deaf or hard of hearing to access behavioral health services and treatment. There is also a toll-free TTY number available to contact Community Care Behavioral Health for assistance finding providers enrolled in the HealthChoices program, getting basic information on treatment, and answering general questions.

The Center for Independent Living South Central PA (CILSCPA) (www.cilscpa.org) is located in Altoona PA and serves adults in seven counties including Blair. Core services include: Peer Counseling, Advocacy, Independent Living Skills, Information and Referral, Transitioning, and secondary services include: Service Coordination, Technical Assistance, and Voter Registration. In addition to these core and secondary services, the Deaf Action and Awareness Programs (DAAP) services include:

- Technical Assistance regarding compliance with the ADA Public Law 94-142 governing public school education and the care and maintenance of hearing aids.
- Interpreter referral services
- The CILS Deaf and Hard of Hearing Specialist maintains a list of certified and experienced interpreters
- Information about hearing dogs
- Information about use of video and TTY phones
- American Sign Language courses are offered several times per year
- Support groups for moral support and increased social opportunities include interpreters and Communication Access Real Time (CART)

The Hearing Loss Association of America (HLAA) Blair County PA Chapter was established in 2016 and the monthly support meetings are for anyone with hearing loss, interested parents, educators, and professionals and are held at the CILSCPA office in Altoona.

The regional Office for the Deaf and Hard of Hearing is located in Johnstown PA. The PA Department of Labor and Industry Office for the Deaf and Hard of Hearing (www.dil.pa.gov) advocates on behalf of people of all ages who are deaf or hard of hearing for equal access to services, acts as a clearing house of information, makes referrals and ensures the provider is communicatively accessible and administers the Sign Language Interpreter and Translator Registration Act.

The Appalachia Intermediate Unit (IU) 8 (www.iu08.org) serves Blair, Cambria, and Somerset Counties and offers support services for Deaf and Hard of Hearing (DHHS) students from birth through age 21. The types of services available include: Intervention in the home of natural setting for deaf and hard of hearing infants and preschoolers and their families, individualized instruction in schools by certified teachers of the Deaf, parent training and support, consultation with school personnel about hearing loss, assistive technology, communication methods, and instructional and/or classroom accommodations, individual hearing testing and amplification system evaluation and loaner programs, sign language interpreters, and school-to-adult life transition services.

Blair HealthChoices/Community Care Clinical Committee in 2016 added a Mental Health Residential Treatment Facility (RTF) for adolescents operated by PAHrtners Deaf Services, a subsidiary of Salisbury Behavioral Management, to the Blair network of care.

Is the County currently utilizing Cultural and Linguistic Competence (CLC) Training?

Yes No

Does the County currently have any suicide prevention initiatives?

Yes No

The Blair County Suicide Prevention Task Force (SPTF) was established in October 2004 and consists of about 25 community members including family survivors of suicide. In 2010 the SPTF partnered with the American Foundation for Suicide Prevention (AFSP) joining the AFSP Central PA Chapter. A Blair AFSP Business Plan is developed for each fiscal year with activities described in the areas of fundraising, survivor programs, prevention/education/research, and public relations. A few of the 2017/18 Blair AFSP/SPTF events include the Out of the Darkness Walk held September 2017, International Survivors of Suicide Loss day in November 2017, training and books for school personnel and students, educating law enforcement as part of the CIT training, outreach to new survivors/families of suicide include a comfort basket with books about suicide survivors and loss, and a support group.

c) Supportive Housing:

1. Capital Projects for Behavioral Health				<input type="checkbox"/> Check if available in the county and complete the section.					
<p>Capital financing is used to create targeted permanent supportive housing units (apartments) for consumers, typically, for a 15-30 year period. Integrated housing takes into consideration individuals with disabilities being in units (apartments) where people from the general population also live (i.e. an apartment building or apartment complex.)</p>									
Project Name	*Funding Sources by Type (include grants, federal, state & local sources)	Total \$ Amount for FY 16-17 (only County MH/ID dedicated funds)	Projected \$ Amount for FY 18-19 (only County MH/ID dedicated funds)	Actual or Estimated Number Served in FY 16-17	Projected Number to be Served in FY 18-19	Number of Targeted BH Units	Term of Targeted BH Units (ex: 30 years)		Year Project first started
Notes:									

2. Bridge Rental Subsidy Program for Behavioral Health				<input type="checkbox"/> Check if available in the county and complete the section.					
Short term tenant based rental subsidies, intended to be a "bridge" to more permanent housing subsidy such as Housing Choice Vouchers.									
	*Funding Sources by Type (include grants, federal, state & local sources)	Total \$ Amount for FY 16-17	Projected \$ amount for FY 18-19	Actual or Estimated Number Served in FY 16-17	Projected Number to be Served in FY 18-19	Number of Bridge Subsidies in FY 16-17	Average Monthly Subsidy Amount in FY 16-17	Number of Individuals Transitioned to another Subsidy in FY 16-17	Year Project first started
Notes:									

3. Master Leasing (ML) Program for Behavioral Health				<input type="checkbox"/> Check if available in the county and complete the section.					
Leasing units from private owners and then subleasing and subsidizing these units to consumers.									
	*Funding Source by Type (include grants, federal, state & local sources)	Total \$ Amount for FY 16-17	Projected \$ Amount for FY 18-19	Actual or Estimated Number Served in FY 16-17	Projected Number to be Served in FY 18-19	Number of Owners/ Projects Currently Leasing	Number of Units Assisted with Master Leasing in FY 16-17	Average subsidy amount in FY 16-17	Year Project first started
Notes:									

4. Housing Clearinghouse for Behavioral Health				<input type="checkbox"/> Check if available in the county and complete the section.					
An agency that coordinates and manages permanent supportive housing opportunities.									
	*Funding Source by Type (include grants, federal, state & local sources)	Total \$ Amount for FY 16-17	Projected \$ Amount for FY 18-19	Actual or Estimated Number Served in FY 16-17	Projected Number to be Served in FY 18-19			Number of Staff FTEs in FY 16-17	Year Project first started
Notes:									

5. Housing Support Services for Behavioral Health

Check if available in the county and complete the section.

HSS are used to assist consumers in transitions to supportive housing and/or services needed to assist individuals in sustaining their housing after move-in.

	*Funding Sources by Type (include grants, federal, state & local sources)	Total \$ Amount for FY 16-17	Projected \$ Amount for FY 18-19	Actual or Estimated Number Served in FY 16-17	Projected Number to be Served in FY 18-19			Number of Staff FTEs in FY 16-17	Year Project first started
Home Nursing Agency (HNA) PATH	PATH Federal Homeless Grant	\$42,708	\$42,708	75	100			1.5	2004
HNA PATH	HSBG MH Base	\$37,253	\$37,253						
HNA PATH	County Match	\$3,039	\$3,039						
Blair Senior DOM Care	HSBG MH Base	\$5,856	\$5,856	15	16			.10	1996
BS DOM Care	County Match	\$213	\$213						
Skills Housing Staff Support	HSBG MH Base	\$83,083	\$83,083	35	40			1.5	1990
Skills Housing Staff Support	County Match	\$9,232	\$9,232						

6. Housing Contingency Funds for Behavioral Health				<input checked="" type="checkbox"/> Check if available in the county and complete the section.					
Flexible funds for one-time and emergency costs such as security deposits for apartment or utilities, utility hook-up fees, furnishings etc.									
	*Funding Sources by Type (include grants, federal, state & local sources)	Total \$ Amount for FY 16-17	Projected \$ Amount for FY 18-19	Actual or Estimated Number Served in FY 16-17	Projected Number to be Served in FY 18-19			Average Contingency Amount per person	Year Project first started
Skills	HSBG MH Base	\$13,500	\$13,500	55	60			\$275	1990
Skills	County Match	\$1,500	\$1,500						
HNA PATH	MH Base	N/A	\$10,000	N/A	30				2017

7. Other: Identify the program for Behavioral Health				<input type="checkbox"/> Check if available in the county and complete the section.					
Project Based Operating Assistance (PBOA is a partnership program with Pennsylvania Housing Finance Agency in which the County provides operating or rental assistance to specific units then leased to eligible persons); Fairweather Lodge (FWL is an Evidenced Based Practice where individuals with serious mental illness choose to live together in the same home, work together and share responsibility for daily living and wellness); CRR Conversion (as described in the CRR Conversion Protocol), other.									
	*Funding Sources by Type (include grants, federal, state & local sources)	Total \$ Amount for FY 16-17	Projected \$ Amount for FY 17-18	Actual or Estimated Number Served in FY 16-17	Projected Number to be Served in FY 17-18	# of Projects Projected in FY 17-18 (i.e. if PBOA; FWLs, CRR Conversions planned)	# of Projects projected in FY 17-18 (if other than PBOA, FWL, CRR Conversion)		Year Project first started
Notes:									

d) Recovery-Oriented Systems Transformation:

Blair County Department of Social Services (DSS) and Blair HealthChoices have met to review relevant data, system progress, and stakeholder input in developing the Human Services Plan for FY 2018/2019. This has included a discussion on recovery-oriented systems transformation. The top five priorities related to these efforts include the following:

1) Increasing Community Tenure

As Blair County continues to transform its service system to become more recovery oriented, measures such as community tenure gain added importance. Despite an increase in access to community-based services, hospitalization rates have not significantly changed. Also, readmission rates continue to be above the benchmark. Both affect a person's time spent in the community and both are disruptive and stressful on the person involved, despite best efforts otherwise.

Up to September 2017, a series of meetings were held to develop the root cause analysis for reducing readmission to the hospital within 30 days of their initial stay. Some of the root causes identified:

- People Root Cause 1: Mental Health Inpatient Hospitalization (MHIP) admissions are not planned and can be disruptive to the flow of an individual's life.
- People Root Cause 2: Community support services are recovery oriented and are able to meet with the individual in a convenient and agreed upon location.
- Providers Root Cause 1: Hospital Social Worker have other duties that take away from exploring adequate discharge options.
- Policies/Procedures Root Cause 1: MHIP is for acute stabilization.
- Provisions Root Cause 1: There is a lack of psychiatrists who are willing to work in rural areas.

Based on the RCA, several interventions were identified and a Pay For Performance was created for the inpatient unit to implement the interventions.

Also, H.O.P.E. Drop In implemented a community outreach effort called "Better Than Roses" to provide a support package to individuals leaving the inpatient unit to assist in a smoother transition back into the community.

In October 2017, an additional psychiatric outpatient clinic was added to Blair County to increase access to psychiatry for adults and children.

In December 2017, using the Human Services Block Grant (HSBG), a Mental Health Forensic Case Manager was hired to support individuals incarcerated with a mental health diagnosis. This allows better screening and coordination of care for inmates, with the goal to reduce recidivism and improve their quality of life in the community. This is one of the first steps in Blair County's Stepping Up Initiative.

Since July 2017, Blair HealthChoices and the BCDSS have been working with the local crisis provider to expand access to mobile crisis through a reinvestment plan and the HSBG. This allows more community outreach to occur in partnership with the police and Children, Youth, and Families (CYF). The service is also being used to outreach to individuals recently discharged from the hospital that do not follow through with their scheduled outpatient appointments. Although, the service is still ramping up, we have already seen a 100% increase in mobile crisis utilization.

Pending approval, Blair HealthChoices submitted a reinvestment plan to establish a single room occupancy annex to provide short-term housing for individuals integrating back into the community. Often times, housing is the barrier to and individual returning to the community from hospitalization, rehabilitation, or prison. This short-term housing will allow individuals to discharge when medically ready and have safe housing and supports through local behavioral health providers to establish a long term plan for continued recovery.

Timeline: Progress is reviewed quarterly, and adjustments to the plan are made accordingly. This will be ongoing until we are able to sustain readmission rates below the benchmark and reduce beds utilized at the state hospital.

Resources needed: Funds may be required to expand or increase services, such as mobile crisis or mobile psychiatric rehabilitation, and assistance in recruiting additional psychiatrists or increasing accessibility to tele-psychiatry.

Plan for tracking implementation: The strategic plan includes goals, measurable objectives, person/s responsible, and timeframes for completion. Updates will be reported regularly to the Healthy Blair County Coalition, Blair County Leadership Coalition and Blair HealthChoices Clinical Committee.

2) Building a Trauma Informed Care Culture in Children's Mental Health

Experiencing a traumatic event can have a long-term impact on a person, affecting his/her body, mind, and spirit. Trauma can overwhelm a person's ability to experience a sense of control over oneself and the immediate environment. It can also make it difficult to maintain connections to others. Despite these challenges, people can recover from the impact of trauma.

Blair County is committed to building a trauma informed care culture in its service system. Trauma informed services are services that incorporate an understanding of the enormous effect of trauma on people. This understanding is built into all levels of an organization and into all interactions with people receiving services to help facilitate recovery. Beginning with children's mental health services, Blair County will take a two-pronged approach for this effort, systemic trauma-informed care and building clinician competencies. A Trauma Summit was held in spring 2016 to incorporate SAMHSA's TIP 57, Trauma Informed Care in Behavioral Health Services. A Trauma workgroup continues to convene monthly and works on four priority areas: agency-wide trauma informed care, identification and assessment, tools and timelines, clinical competencies and evidence-based practices. In June 2017, a training was held for Peer Support Specialists to build skill competencies in trauma informed care and therapeutic boundaries.

In addition, Blair County continues to facilitate a Multi-Disciplinary Investigative Team (MDIT) Protocol and is continuing to work toward the accreditation of a Child Advocacy Center, which opened in September 2017. Coordination of trauma therapy and other supportive services for children and their families are an integral part of a Child Advocacy Center, with accreditation requiring trauma treatment to be evidence-based.

Blair HealthChoices was awarded a PCCD grant in September 2016 to train up to 24 licensed or licensed eligible therapists in Trauma Focused Cognitive Behavioral Therapy (TFCBT). To date, 19 therapists completed their supervision groups. Three therapists are now certified. In April 2018, ongoing supervision was established monthly for six months to continue to support clinicians seeking certification. An advanced TFCBT training was held in June 2017 and was attended by most of the therapists involved in the grant. In May 2018, a TFCBT clinician retreat is being held and the clinicians continue to remain involved in the process. A referral process from the Child Advocacy Center to the TFCBT therapists has been established.

Timeline:

The goal is to continue to increase the number of TFEBT certified therapists and establish a fidelity monitoring process by January 2018.

Resources needed:

Continue to have access to grants to support the Child Advocacy Center.

Plan for tracking implementation:

The MDIT Steering Committee will track progress related to the accreditation of the Child Advocacy Center. Blair HealthChoices will continue to monitor the number of therapists obtaining TFEBT certification.

3) Increase Quality and Consistency with Services Related to Prevention and Early Identification of Behavioral Health Issues for Children and Youth

Pennsylvania's Student Assistance Program (SAP), is designed to assist school personnel in identifying issues including drugs and mental health issues that pose a barrier to a student's success. The primary goal of the Student Assistance Program (SAP) is to help students overcome these barriers so that they achieve, remain in school, and advance.

SAP is a systemic process using techniques to mobilize school resources to remove barriers to learning. SAP team members are trained to identify problems, determine whether or not the presenting problem lies within the responsibility of the school, and make recommendations to assist the student and his/her family. When the problem is beyond the scope of the school, the SAP team will assist the student and family with accessing services within the community.

Blair County DSS has a robust SAP program for children and youth. Efforts coordinated through the Blair County DSS and the Blair County Drug and Alcohol Partnership (BC DAP) in the FY 2016-2017 include:

- Inviting the MH and Drug and Alcohol (D&A) agencies providing outpatient treatment in the school setting to join the SAP Coordination Team which include Alternative Community Resource Program (ACRP) Blair Family Solutions, Cen-Clear, Home Nursing Agency for mental health treatment, and Impact Counseling, and LaRocco Counseling for drug and alcohol treatment.
- Revision of the County Drug and Alcohol (D&A) Partnership, and County MH/SAP Provider/School District annual letters of agreement using the PA Department of Education (DPE), and DHS/OMHSAS/D&A template, which includes a Blair specific agency protocol to clarify roles/responsibilities and best practice approaches to shorten the time from the SAP screen to assessment and treatment services in the school and community, and to enhance communication between the SAP partners.
- A screening tool was developed and is being utilized by both MH and D&A SAP liaisons.
- The SAP MH contract with UPMC Altoona was expanded by adding 1 FTE (Full Time Equivalent) to provide MH liaison to the elementary SAP teams.
- UPMC Altoona SAP MH Liaisons served 638 unduplicated students in FY 2015/16 and 997 in FY 2016/17, and 893 in the current FY through March 2018. The SAP MH student demographic and encounter data is in the process of further analysis and comparison to the data reported and aggregated by the PA Department of Education.

Timeline: Accomplishments for FY 2017/2018 will be documented and action steps/activities/responsible party for the FY 2018/2019 will be in place by September 2018.

Resources needed: Additional resources are not needed for efforts at increasing consistency of SAP services throughout the school system or with monitoring fidelity to the model. Funds would be required to expand SAP MH liaison services to additional elementary SAP Teams in the County.

Plan for tracking implementation: The Blair County Department of Social Services (DSS) MH Director and the Independent Single County Authority (SCA) at Blair County Drug and Alcohol Partnership (BDAP) will work together with the Blair Student Assistance Program (SAP) Coordination Team to set the specific goals, objectives, responsible persons and timeframes for the school year 2017/2018. Reports will be given routinely at the Blair SAP District Council, Blair SAP Coordination Team, CASSP Advisory Committee, the Blair County DSS MH Committee and Advisory Board, the BDAP Board and the Leadership Coalition for the Blair Human Services Block Grant.

4) Increase Housing Options and Supports

In April 2015, through HSBG retained earnings, a Housing Summit was held to learn about housing models in other counties and also spend time brainstorming opportunities in Blair County. A Housing Steering Committee was established to develop a Strategic Plan. Three priority areas were established: educating and supporting landlords; educating and supporting tenants; and providing safe, affordable, and accessible housing.

The PREP Train the Trainer Training was provided March 2017 to 38 individuals including Blended Case Managers, members of Lexington Clubhouse, Housing Support Staff, Drop In Center leadership, Drug and Alcohol Case Management, Prison Staff, Probation Officers, and others that support and advocate for those that struggle to find and maintain housing. Since the training, three programs have reported back setting up training at their agency utilizing the curriculum, the shelter holds classes every Saturday, the Blair House, and a re-entry program at the Blair County prison. Another PREP Train the Trainer was held in March 2018, training an additional 21 community members. Another training is being held in May 2018 for all Adult Probation Officers.

Blair County continues to work toward building a shelter with increased capacity to meet the needs of the county, as well as, expand transitional housing opportunities. A new teen shelter was opened in Blair County in November 2016, with drop in hours for youth.

Blair HealthChoices recently submitted a reinvestment plan to develop three separate housing projects, support a housing manager to assist and support individuals in the housing units, and have contingency funds to prevent homelessness.

The BCDSS is also applying for a grant to support 5-10 individuals with mental illness upon release from Blair County jail to provide safe housing and effectively reintegrate back into the community.

Timeline:

Continue to expand capacity for PREP Trainer, as well as, utilize the PREP curriculum in the community. Expand housing opportunities and housing supports to prevent recidivism.

Resources needed:

Continue funding opportunities to expand housing options.

Plan for tracking implementation:

The strategic plan is reviewed quarterly at the Housing Steering Committee.

5) Fostering Data Driven Decision Making

While funding streams often silo programs, the reality is that individuals access services without much regard to whether they are HealthChoices or Block Grant funded. They are simply trying to get the care and treatment to address their behavioral health needs.

In order to consider the systems, and thereby the individuals using these systems, comprehensively and as a whole, the Blair County Department of Social Services (BC DSS), in partnership with Blair HealthChoices, is working on meaningful data integration that is efficient and helpful in decision-making from a systemic level, as well as, at the individual level. The goal is to develop a data warehouse that provides information that paints a more complete data picture related to who is using which services, in what amount and at what costs. This will assist BC DSS in developing a strategy for assessing needs and better allocating resources across systems.

Over the long-term, the aim is to integrate data across the entire BC DSS system; however, due to the importance of such an endeavor, we need to begin quickly - with the integration of mental health data from the HealthChoices and County-funded programs.

The data warehouse design strategy will center on open-systems architecture and off-the-shelf hardware and software. This strategy will offer distinct advantages in terms of flexibility, adaptability, and the elimination of any technical barriers to adoption and utilization.

Timeline:

Data elements have been aligned. A Business Associate Agreement is currently under review. We anticipate full integration by September 2018.

Resources needed:

The additional cost is still being assessed. We anticipate shared administrative costs between county based funds and HealthChoices.

Plan for tracking implementation:

Status update meetings will be held monthly between BC DSS and Blair HealthChoices.

e) Existing County Mental Health Services:

Services By Category	Currently Offered	Funding Source (Check all that apply)
Outpatient Mental Health	<input checked="" type="checkbox"/>	<input checked="" type="checkbox"/> County <input checked="" type="checkbox"/> HC <input type="checkbox"/> Reinvestment
Psychiatric Inpatient Hospitalization	<input checked="" type="checkbox"/>	<input type="checkbox"/> County <input checked="" type="checkbox"/> HC <input type="checkbox"/> Reinvestment
Partial Hospitalization		
Adult	<input checked="" type="checkbox"/>	<input checked="" type="checkbox"/> County <input checked="" type="checkbox"/> HC <input type="checkbox"/> Reinvestment
Child/Youth	<input checked="" type="checkbox"/>	<input type="checkbox"/> County <input checked="" type="checkbox"/> HC <input type="checkbox"/> Reinvestment
Family-Based Mental Health Services	<input checked="" type="checkbox"/>	<input type="checkbox"/> County <input checked="" type="checkbox"/> HC <input type="checkbox"/> Reinvestment
ACT or CTT	<input type="checkbox"/>	<input type="checkbox"/> County <input type="checkbox"/> HC <input type="checkbox"/> Reinvestment
Children’s Evidence Based Practices	<input checked="" type="checkbox"/>	<input type="checkbox"/> County <input checked="" type="checkbox"/> HC <input type="checkbox"/> Reinvestment
Crisis Services		
Telephone Crisis Services	<input checked="" type="checkbox"/>	<input checked="" type="checkbox"/> County <input checked="" type="checkbox"/> HC <input type="checkbox"/> Reinvestment
Walk-in Crisis Services	<input checked="" type="checkbox"/>	<input checked="" type="checkbox"/> County <input checked="" type="checkbox"/> HC <input type="checkbox"/> Reinvestment
Mobile Crisis Services	<input checked="" type="checkbox"/>	<input checked="" type="checkbox"/> County <input checked="" type="checkbox"/> HC <input checked="" type="checkbox"/> Reinvestment
Crisis Residential Services	<input type="checkbox"/>	<input type="checkbox"/> County <input type="checkbox"/> HC <input type="checkbox"/> Reinvestment
Crisis In-Home Support Services	<input type="checkbox"/>	<input type="checkbox"/> County <input type="checkbox"/> HC <input type="checkbox"/> Reinvestment
Emergency Services	<input checked="" type="checkbox"/>	<input checked="" type="checkbox"/> County <input type="checkbox"/> HC <input type="checkbox"/> Reinvestment
Targeted Case Management	<input checked="" type="checkbox"/>	<input checked="" type="checkbox"/> County <input checked="" type="checkbox"/> HC <input type="checkbox"/> Reinvestment
Administrative Management	<input checked="" type="checkbox"/>	<input checked="" type="checkbox"/> County <input type="checkbox"/> HC <input type="checkbox"/> Reinvestment
Transitional and Community Integration Services	<input checked="" type="checkbox"/>	<input checked="" type="checkbox"/> County <input type="checkbox"/> HC <input type="checkbox"/> Reinvestment
Community Employment/Employment Related Services	<input checked="" type="checkbox"/>	<input checked="" type="checkbox"/> County <input type="checkbox"/> HC <input type="checkbox"/> Reinvestment
Community Residential Services	<input checked="" type="checkbox"/>	<input checked="" type="checkbox"/> County <input type="checkbox"/> HC <input type="checkbox"/> Reinvestment
Psychiatric Rehabilitation	<input checked="" type="checkbox"/>	<input checked="" type="checkbox"/> County <input checked="" type="checkbox"/> HC <input type="checkbox"/> Reinvestment
Children’s Psychosocial Rehabilitation	<input checked="" type="checkbox"/>	<input type="checkbox"/> County <input checked="" type="checkbox"/> HC <input type="checkbox"/> Reinvestment
Adult Developmental Training	<input type="checkbox"/>	<input type="checkbox"/> County <input type="checkbox"/> HC <input type="checkbox"/> Reinvestment
Facility Based Vocational Rehabilitation	<input checked="" type="checkbox"/>	<input checked="" type="checkbox"/> County <input type="checkbox"/> HC <input type="checkbox"/> Reinvestment
Social Rehabilitation Services	<input checked="" type="checkbox"/>	<input checked="" type="checkbox"/> County <input type="checkbox"/> HC <input type="checkbox"/> Reinvestment
Administrator’s Office	<input checked="" type="checkbox"/>	<input checked="" type="checkbox"/> County <input type="checkbox"/> HC <input type="checkbox"/> Reinvestment
Housing Support Services	<input checked="" type="checkbox"/>	<input checked="" type="checkbox"/> County <input type="checkbox"/> HC <input type="checkbox"/> Reinvestment
Family Support Services	<input checked="" type="checkbox"/>	<input checked="" type="checkbox"/> County <input type="checkbox"/> HC <input type="checkbox"/> Reinvestment
Peer Support Services	<input checked="" type="checkbox"/>	<input type="checkbox"/> County <input checked="" type="checkbox"/> HC <input type="checkbox"/> Reinvestment
Consumer Driven Services	<input checked="" type="checkbox"/>	<input checked="" type="checkbox"/> County <input type="checkbox"/> HC <input type="checkbox"/> Reinvestment
Community Services	<input type="checkbox"/>	<input type="checkbox"/> County <input type="checkbox"/> HC <input type="checkbox"/> Reinvestment
Mobile Mental Health Treatment	<input checked="" type="checkbox"/>	<input type="checkbox"/> County <input checked="" type="checkbox"/> HC <input type="checkbox"/> Reinvestment
BHRS for Children and Adolescents	<input checked="" type="checkbox"/>	<input checked="" type="checkbox"/> County <input checked="" type="checkbox"/> HC <input type="checkbox"/> Reinvestment
Inpatient D&A (Detoxification and Rehabilitation)	<input checked="" type="checkbox"/>	<input type="checkbox"/> County <input checked="" type="checkbox"/> HC <input type="checkbox"/> Reinvestment
Outpatient D&A Services	<input checked="" type="checkbox"/>	<input type="checkbox"/> County <input checked="" type="checkbox"/> HC <input type="checkbox"/> Reinvestment
Methadone Maintenance	<input checked="" type="checkbox"/>	<input type="checkbox"/> County <input checked="" type="checkbox"/> HC <input type="checkbox"/> Reinvestment
Clozapine Support Services	<input checked="" type="checkbox"/>	<input checked="" type="checkbox"/> County <input checked="" type="checkbox"/> HC <input type="checkbox"/> Reinvestment
Additional Services (Specify – add rows as needed)	<input type="checkbox"/>	<input type="checkbox"/> County <input type="checkbox"/> HC <input type="checkbox"/> Reinvestment

*HC = HealthChoices

f) Evidence Based Practices Survey:

Evidenced Based Practice	Is the service available in the County/ Joinder? (Y/N)	Current Number served in the County/ Joinder (Approx)	What fidelity measure is used?	Who measures fidelity? (agency, county, MCO, or state)	How often is fidelity measured ?	Is SAMHSA EBP Toolkit used as an implementation guide? (Y/N)	Is staff specifically trained to implement the EBP? (Y/N)	Additional Information and Comments
Assertive Community Treatment	No							
Supportive Housing	No							
Supported Employment	No							Include # Employed
Integrated Treatment for Co-occurring Disorders (MH/SA)	No							
Illness Management/ Recovery	No							
Medication Management (MedTEAM)	No							
Therapeutic Foster Care	Yes	7						
Multisystemic Therapy	Yes	33						
Functional Family Therapy	Yes	72						
Family Psycho-Education	No							

g) Additional EBP, Recovery Oriented and Promising Practices Survey:

Recovery Oriented and Promising Practices	Service Provided (Yes/No)	Current Number Served (Approximate)	Additional Information and Comments
Consumer/Family Satisfaction Team	Yes	Approx. 500	
Compeer	No		
Fairweather Lodge	No		
MA Funded Certified Peer Specialist- Total**	Yes	260	
CPS Services for Transition Age Youth			
CPS Services for Older Adults			
Other Funded Certified Peer Specialist – Total**	No		
CPS Services for Transition Age Youth			
CPS Services for Older Adults			
Dialectical Behavioral Therapy			
Mobile Meds	No		
Wellness Recovery Action Plan (WRAP)	Yes		
High Fidelity Wrap Around/Joint Planning Team	No		
Shared Decision Making	No		
Psychiatric Rehabilitation Services (including clubhouse)	Yes	62	
Self-Directed Care	No		
Supported Education	No		
Treatment of Depression in Older Adults	Yes		
Consumer Operated Services	Yes		
Parent Child Interaction Therapy	Yes	17	
Sanctuary	No		
Trauma Focused Cognitive Behavioral Therapy	Yes	unknown	
Eye Movement Desensitization And Reprocessing (EMDR)	Yes	unknown	
First Episode Psychosis Coordinated Specialty Care	No		
Other (Specify)			

*Please include both County and Medicaid/HealthChoices funded services.

**Include CPS services provided to all age groups in Total, including those in the age break outs for TAY and OA below

h) Certified Peer Specialist Employment Survey:

Total Number of CPSs Employed	26
Number Full Time (30 hours or more)	13
Number Part Time (Under 30 hours)	13

Intellectual Disability Services

The Everyday Lives principles have been driving the Blair County IDD system since their establishment in the early 1990's. Through Person Centered Thinking (PCT) and Person Centered Planning (PCP), Southern Alleghenies Service Management (SASMG) supports the residents of Blair County to experience an Everyday Life. Blair County/SASMG has provided free Person Centered Thinking Training for any employee in Blair County, in fact, the expectation is that each employee will complete the training within 60 days of hire. This training has always been provided by a credentialed PCT trainer or Mentor Trainer. Training is just the beginning of exposure to PCT, PC Coaching and The Blair County Community of Person Centered Practices has offered learning and support for over 13 years. To further address the principles of Everyday Lives SASMG is participating in the Statewide Community of Practice to Support Families Across the Lifespan as a regional collaborative. The collaborative

SASMG is a non-profit agency, under contract with the County of Blair to deliver the requirements of the Administrative Entity Operating Agreement. SASMG also manages all funding streams for people with intellectual disabilities. The service system starts at Intake, and includes the management of supports for all of the six hundred eighty one (681) people who are active. Each person, regardless of his or her place of residence (from state centers to a private apartment) or the services that they are receiving chooses a Supports Coordinator (SC). Along with all team members, the SC facilitates the development of a plan in the Home and Community Services Information System (HCSIS), authorized by SASMG.

The majority of eligible service recipients receive services through the three Medicaid Waivers. The non-waiver block grant funds are available for emergencies, one-time adaptations, and needed equipment for people so that they can remain in their current residence or respite so that their family members can have a much-needed break. The ability to support families in any way reduces the burden on the County and offers an 'Everyday Life' to all. Each person's plan identifies strengths, gifts and needs regardless of funding opportunities.

It is the firm belief from the perspective of SASMG that everyone has a place in society and can make a contribution. The continued focus on community and employment will drive our system into the future.

Individuals Served

	Estimated Individuals Served in FY 2017/2018	Percent of Total Individuals Served	Projected Individuals to be Served in FY 2018/2019	Percent of Total Individuals Served
Supported Employment	7	.01	12	.017
Pre-Vocational	0	0	0	0
Community Participation	1	.001	1	.001
Base Funded Supports Coordination	70	.103	80	.117
Residential (6400)/unlicensed	0	0	0	0
Life sharing (6500)/unlicensed	0	0	0	0
PDS/AWC	5	.007	10	.015
PDS/VF	0	0	0	0
Family Driven Family Support Services	0	0	0	0

Supported Employment:

Local agencies currently provide career assessments, job development, follow up services, continued services and customized employment within the scope of Employment services. The Discovery model is provided by three agencies and compliments the PC approaches of strength based job searching. The most successful jobs are found through exploring the person's interests and strength's. On the job support is tailored to the needs of the person and provided by Employment Agencies.

An informal memorandum of understanding continues to exist between the local OVR office and the AE. Funds are prioritized for people to retain jobs, or have follow up after an OVR assessment. These funds are among the first prioritized after allocation.

To address the barrier of families expecting service and having little confidence in their loved one obtaining gainful employment after graduation, SASMG has sponsored a summer employment grant for the past four fiscal years. SASMG has partnered with the Block Grant Leadership Coalition to increase the number of opportunities this grant provides as well as to broaden the population of students. The grant helps students have a typical high school work experience. Funds for 4 grants have been allocated at \$10,000 each. Last year 25 students were able to have some paid work experience.

Through outreach and community partnerships SASMG continues to work on the relationships with local businesses to create opportunities and change.

Supports Coordination:

Paired with the Life course Grant and Community of Practice, a service request form has been implemented that requires the SCO to explore natural supports prior to the request of paid services. To enhance the skills of Supports Coordinators (SC)'s, we recognize the need for additional training on how to build bridges and how to identify generic and natural supports.

At the request of a small number of families, SASMG worked to recruit other SCO's that wish to provide service to Blair County's residents. Effective January 1, 2018 Blair County now has 4 SCO's to provide choice to people and their families. The SCO's are Northstar Services, Center for Community Resources, Service Access Management, and Family Links.

In a Person Centered Planning environment, families are encouraged to contribute to the learning that teams need as they plan for a person. SC's are counseled to make every effort to include families in the planning process so as not to jeopardize the current natural supports. Some families may feel that they are not welcome anymore, and we will make efforts to make sure they understand that they are valuable. Some families think that we know better, therefore, they don't feel needed anymore. With the implementation of the Life course Curriculum, families will learn more about the system and be better able to realize their loved one's potential. Data suggests that the preponderance of the people supported live with families and that relationship needs to be respected and supported.

Life Sharing Options:

Life sharing continues to be priority in Blair County. Many of the longest relationships have resulted from Life sharing. SASMG will continue to participate in Life sharing groups, as well as ensuring that this is discussed before all other living options when planning with a person. The changes in the definitions should allow a greater flexibility and clarity to the service, including the ability for blood families to provide Life Sharing.

The barriers to Life sharing often resulted in the funding arrangement between agencies and families as well as the lack of potential families.

Life sharing has remained static, with very little growth or change year to year. ODP could share successes of where families were recruited from and other successful models of Life sharing.

Cross Systems Communications and Training:

Blair County created a Leadership Coalition in 2012 in response to the block granting of state funds, which continues to operate to deliver the priorities of service needs that the strategic planning process identified; housing, transportation and employment as needs across all residents of the county. Coalition members include County Commissioners, the County Social Services Director and Management of all agencies who have funds within the Block Grant. This diverse group has the ability to identify and recommend supports that will more fully respond to the needs of people with multiple needs. During monthly review meetings initiatives that have been developed that address the strategic priorities are identified, decisions made as to the urgency and consensus to respond to the requests are made.

SASMG has been a regular active member of the local Transition Council. A bi-annual Transition Expo was executed. This expo focused on transition age youth and their families. The Life course was critical piece of the information and was demonstrated to over 225 family members.

SASMG collaborates with many social services agencies through participation in various committees, i.e., Children Youth and Families, Diversionary team meetings, Healthy Blair County Coalition etc. Efforts are made to participate in wellness fairs, block grant coalition meetings, the dual diagnosis steering committee, the County Advisory Board, and various work groups that are established along the way. The Dual Diagnosis navigator position has worked to bridge the gap between Mental Health and Intellectual Disability systems. Partnership with co-workers in all providers has enhanced the ability to support people wholly.

Emergency Supports:

The staff of Southern Alleghenies Service Management Group and the Management team from the Supports Coordination Organizations, meet at least monthly to review the PUNS, discuss emergent issues, cooperate with waiver admissions and sort out any/all issues with people being supported. SC's alert SC supervisors of potential issues as soon as they are aware. Any 'high profile' issues are identified and potential crises are often dealt with prior to an untenable situation. SASMG's ID and Executive Director are accessible at all times via published cell phone numbers.

In addition, the Staff from NSS rotate 'on call' duties with the local Crisis center so that when a person who uses intellectual disability services presents at the outpatient center, a Supports Coordinator gets involved to assure that the needs of the person are met. Additionally, an electronic record that is remotely accessible by the on call SC is kept up to date for each person.

The incident reporting requirements in HCSIS are monitored by SASMG staff 7 days a week, keeping us informed of any/all issues as soon as they arise. Agencies and Supports Coordinator directors are free to contact management of SASMG at any time, should there be a need.

In previous years Blair County was able to count on the use of Family Service's respite home to handle emergencies. Unfortunately that service was ended in the fall of 2017. SASMG continues to recruit and coordinate with other agencies to develop this service.

SASMG monitors the block grant funds that we are responsible for, assuring enough funds throughout the year to respond to any unforeseen emergency without unnecessary encumbrance of funds.

Blair County's Emergency Management Agency has initiated a registration push for a new electronic register called Smart911. Smart911 asks every person who has a disability, intellectual, physical or emotional to register with the local 911 center. This software allows for the timely identification of any considerations or special conditions the EMS may need to know. Additionally two crisis simulations have been conducted for disaster preparedness.

24-hour Emergency Response Plan for Intellectual Disabilities Services

Reference- Mental Health and Intellectual Disabilities Act of 1966

In accordance with the Mental Health and Intellectual Disabilities Act of 1966 this policy establishes a 24- hour Emergency Response Plan for Intellectual Disabilities Services in Blair County.

To prevent emergencies the contracted Administrative Entity (AE) Southern Alleghenies Service Management Group (SASMG) and the contracted Supports Coordination Organization (SCO) NorthStar Services (NSS) monitor and review the Prioritization of Urgency for Service (PUNS) list and specific at risk cases every two weeks or more frequently as needed. Funds and resources are allocated to prioritize the health and safety of Blair County residents. All people open with the Intellectual Disabilities program will be offered registration with Blair County's smart911 system.

In the event of an unanticipated emergency, NSS maintains a 24 hour on call system (814) 327-8141. This on-call system assures contact with a professional who has access to any needed records, contacts, or emergency information for the person in an emergency situation. Paired with the cooperation of the UMPC crisis center (814) 889-2011 the majority of situations are resolved without further need for intervention.

If the situation requires emergent placement, other safeguards have been established to ensure the health and safety of the person. Family Services Inc. operates a respite facility that offers temporary housing for people with Intellectual disabilities. An agreement exists that funds will be provided from the emergency reserve to address any emergency situations. If capacity does not exist at the moment of issue at the respite home, other residential providers with vacancies in community homes are contacted. Each agency maintains an on call number that is accessible to NSS. If no homes have the capacity to serve the person, the AE Executive Director 814-414-2718 is contacted to authorize payment to a local hotel, while staff coverage through in home providers are arranged by the SCO.

If the situation does not require placement, in home supports are acquired by the SCO to assist in the person's own residence by following the above procedure.

Administrative Funding:

Through participation in the Life course Community of Practice, SASMG has utilized trainers to target two groups. The first Group was the transition aged families from the transition expo. The second group was all SC's in Blair County. We are still working to recruit Mentor Families. SASMG has developed the Vision for the trajectory of Blair County. "A community where everyone is accepted and respected."

SASMG has been training staff from all agencies in Person Centered Thinking Principles for many years and has offered family attendance. If families are knowledgeable about Person Centered Practices, that may go a long way in assuring that all personnel of all agencies are sure to follow them at all times. The more informed people are, the better their service design can be. Our intention is to utilize the Life course curriculum to develop networks for families and connections to natural supports.

The Health Care Quality Unit (HCQU) Nurse assigned to Blair County is active on many committees, i.e., Risk Management, Providers Group, Quality Assurance and the Human Rights Committee. She is available for trainings to the system on many topics. She is used as consultation and advocacy for any medical related issues as needed. HCQU data identified is used to generate targets and goals for the Risk management group as well as for the Quality plan.

SASMG staff along with representation from the SCO's meet quarterly with the Independent Monitoring for Quality (IM4Q) Program Manager to discuss considerations around quality of life. Data is used in our plan around employment, satisfaction with where people live and communication. It would be helpful if there were more interviews conducted to gather better data, which could be accomplished with additional funding to IM4Q. Also, follow upon identified issues would be valuable.

Blair's Risk Management group meets monthly, with representatives from the AE, SCO's, Providers and the HCQU. A website was developed to share guidance tools, supervision tip sheets, and best practices for incident management reporting for consistency to help teams' better support people. A quarterly newsletter is published and is accessible to all provider agencies. ODP has been involved as Theresa Toombs and Randy Evertts have been an integral part of planning.

Capacity for people with a dual diagnosis is at a premium in Blair County. Recruitment and development of provider agencies with the necessary skill sets to support people with complex needs has been difficult. One support that ODP could provide would be contact information and a reputation description for any agencies that are skilled in this support.

Currently, there is not a county housing coordinator in Blair County. Nor have any funds been allocated for this position, though the need is present.

Participant Directed Services (PDS):

The concept of participant directed services meets the intent of person centered practices. The practice of participant directed services sometimes does not. A few service recipients and families choose Participant Directed Supports/Agency with Choice (PDS/AWC) options because they are truly interested in assuring that they have control over their services and take full responsibility to assure following all of the rules. Unfortunately, there are a few who see the opportunity through the Participant Directed Supports/Vendor Fiscal (PDS/VF) model to hire friends and family members at the published rates, which is significantly higher than the entry level rate of provider agencies in Blair

County. Some of these families are continually warned of hour limits, overtime, etc. The PPL Agency does little to no follow up with any identified issues.

Self-direction of service is one of the first items discussed by the SC at any meeting. SASMG is focused on learning all of the requirements to promote PDS in light of the family focus and changes to the waivers and service definitions.

Financial Management Services (FMS) is a being more actively supported with the two brokers that offer services in Blair County. This service helps remove some of the anxiety from the family and prevents the SC from over stepping their role.

Following the sessions to be provided by the partnership additional training will be requested from ODP to strengthen family and system understanding.

Community for All:

Blair County's census at state operated Intermediate Care Facilities for people with Intellectual Disabilities (ICF/ID) is twenty-nine. One hundred fifty eight people live in licensed residential settings, and twenty- four live in licensed Life sharing homes. Eighty eight attend Vocational Training facilities, and the census at five Adult Training Facilities is two hundred nineteen. The on-going goal of all teams is to help people supported and their families to access less restrictive services. Employment is a high priority for those who have spent time in vocational training and are thinking about the next move. In addition, all Adult Training Facilities work hard to give everyone opportunities to engage in community activities that are specific to the needs and wants of each person. The adherence to the CMS final rule will continue to assist people to explore the options of an Everyday Life.

Homeless Assistance Services

Services To Be Provided

Bridge Housing

Blair County Community Action Agency (BCCAA) and Family Services Inc. receive Housing Assistance Program (HAP) dollars for Bridge Housing. These are transitional services that allow clients who are in temporary housing to move to supportive long-term living arrangements while preparing to live independently. This is the “bridge” that moves the client from being homeless into permanent housing. This service allows the client to stay in a shared facility or apartment for up to 12 months for a small fee.

Blair County Community Action Agency will serve 30 individuals (projected) in FY 2018/2019. The actual number of individuals served by Blair County Community Action Agency in FY 2017/2018 YTD was 22.

The actual number of individuals served by Family Services Inc. in FY 2017/2018 YTD was 22.

The actual number of individuals served by Blair County Community Action Agency and Family Services Inc. in FY 2017/2018 was 44.

The target group served by BCCAA includes individuals and families who are homeless and either living in the streets or in shelters. Program participants are eligible to stay in the provided bridge housing for up to 12 months. Bridge housing will be scattered site and will be leased. The cost of renting units for the bridge housing is covered with a combination of HAP and Housing and Urban Development (HUD) funds. The programs utilized falls under BCCAA’s Rapid Re-Housing Programs (RRH). Rent paid for units will not exceed the Fair Market Rate published by HUD for Blair County. Each unit to be rented is inspected to ensure that it meets the HUD Housing Quality Standards. Supportive services provided to participants are designed to move clients into permanent housing and enable them to become self-sufficient. The costs associated with the delivery of supportive services are paid for with funds from HUD and Blair County Community Action Agency. Upon entrance into the program, each client is assigned a Case Manager. Initially, the clients complete an intake/assessment to determine their needs. Upon completing the intake/assessment phase of the program, the Case Manager determines housing alternatives for each participant based upon their status at the time of the interview. The client and Case Manager explore alternatives and strategies that can be used to work toward obtaining and maintaining permanent housing. The assessment ends with the creation of a Housing Development Plan, which will include goals and objectives for clients to work towards more stabilization and self-sufficiency.

The following supportive services are available to clients in the Bridge Housing program. Employment Assistance – every effort is made to assist clients in obtaining employment. Finding employment is a primary objective for the clients served for two reasons: (1) clients will not have the financial means to obtain permanent housing without employment; and (2) landlords are reluctant to lease to persons who are unemployed. Case Management – Services are provided to each client on an individual basis. BCCAA assigns a Case Manager who performs activities which insure that each participant has access to and receives resources and services which help them to reach their highest level of function and productivity. Child Care – BCCAA provides clients (who meet the HUD homeless criteria and are not able to access other child care assistance) with \$200.00/month for six months while they are participating in the program. Transportation – there is a limited public transportation system in the City of Altoona that is available to clients. There isn’t any public transportation available in the rural areas of Blair County. To address this need, clients can be referred to BCCAA’s Employment Transportation program to transport clients to job interviews or employment. Bus passes are given to clients who have access to public transportation, for short term needs. Clothing Allowance – each client (who

meets the HUD homeless criteria) is eligible to receive \$200.00 (one time only) towards the purchase of clothing so that they can be properly dressed for job interviews. Moving Costs – One (1) time moving costs are available to RRH consumers when they successfully exit the program. Food Vouchers – Vouchers will be provided to individuals or families to assist with emergency food in the home or on an as requested basis. Food Bank referrals – the Altoona Food Bank is located in the same building as BCCAA. Each participant is eligible to receive a food bank referral for a maximum of 12 times per year. The need is determined during the intake/assessment phase of the program. Housing Counseling – Each client is mandated to attend two (2) money management workshops at BCCAA to improve their money management skills.

Housing Placement assistance is one of the activities that case managers engage in with clients to ease the move from bridge housing to permanent housing. There are several activities that clients and case managers pursue that constitute Housing Placement Assistance. First, immediately upon entry into the program, case managers assist clients in applying for Section 8 and subsidized housing through both the Altoona and Blair County Housing Authorities. Case managers provide budget counseling to clients to ensure that they can budget their money wisely and prioritize how they spend their money so that money can be saved for a security deposit and for rent when they are ready to move into permanent housing. All clients are expected to pay 30% of their adjusted gross income as a fee for living in the bridge housing unit. A portion of the money paid by each client will be put into a savings account. When the client is ready to leave transitional housing and move into permanent housing this money can be used as a security deposit/first month's rent for an apartment.

Until February 1, 2018, Family Services Inc. received Housing Assistance Program (HAP) dollars for Bridge Housing. These are transitional services that allow clients who are in temporary housing to move to supportive long-term living arrangements for a small fee, while preparing to live independently. However, during the 2017/2018 fiscal year, Family Services Inc., closed the Domestic Abuse shelter, and in doing so ceased offering Bridge Housing services. HAP funds will be used to offer additional housing services to victims of crimes facing homelessness. Please see the numbers below for YTD information.

Affordable housing remains a top need for survivors of domestic violence, as homelessness is one of the largest reasons victims stay in abusive relationships. Moving forward, Family Services Inc. will utilize HAP funds to fund 3 priority areas: Case Management, Rental Assistance, and Emergency Shelter. Closing the Domestic Abuse Shelter allows Family Services Inc., through the Victim Services Program, to take a housing first approach when working with survivors of domestic abuse. In doing so, the program has hired a Housing Advocate. This new position dedicates a staff person to working with survivors of domestic abuse, sexual assault, and other crimes who are facing homelessness because of their victimization. The Housing Advocate will work individually with survivors to determine budgetary realities, assess needs, and analyze housing options.

To ensure survivors obtain long-term, stable, and safe housing, Family Services Inc. will be paying for housing needs costs, such as first and last months' rent and/or security deposits for survivors in need. HAP funds will be used for this rental assistance.

The objective is to help clients remain free from violence while moving towards emotional and financial stability and ultimately achieving self-sufficiency and living independently. Safety remains priority for victims and survivors. Often, victims must flee their homes to remain safe. HAP funds will be used to provide safe, temporary emergency shelter for survivors, utilizing already existing agreements with local hotels.

When a survivor is in a hotel, she/he will begin immediately working with the Housing Advocate to find long-term stable housing. Through this process, the Housing Advocate will provide individual case management with the survivor, creating a realistic budget, assessing needs, preparing the person to be good renters so they maintain stable housing, and more.

Families will continue with the Housing Advocate and their assigned Counselor Advocate after they have obtained housing. This will ensure comprehensive services and ensure their safety needs are being met. This will increase the likelihood of that family remaining housed in long-term housing and staying safe from violence.

Individuals served in the Bridge Housing Program, and moving forward, who will be served by the Housing Advocate obtained necessary income and were educated regarding healthy relationships, personal safety, budgeting, effects of trauma, and community resources available to assist them. New mobile advocacy and follow up services have been instrumental in maintaining healthy support and encouragement for families after exiting shelter. In April 2016, Family Services began offering free Civil Legal Representation services to victims of domestic violence receiving services from their Domestic Abuse Program.

At the third meeting with the Housing Advocate, survivors are asked to complete an Empowerment and Satisfaction Questionnaire- Long Form. This questionnaire has 7 parts which focus on client perceptions of services they received and how beneficial they were in the following ways: increasing sense of empowerment, rating facility in terms of comfort/ease, increased knowledge of, or experience with, the medical system, increased access to and knowledge of necessary services through the legal system, access to victims compensation program, decrease in harmful effects of trauma (physically and mentally), and the overall helpfulness of our program. This form also asks for basic demographic information. The questionnaires are analyzed and reviewed in an effort to continue improving service provision.

Utilizing this new housing first model, Family Services Incorporated projects that the program will assist a minimum of 13 families in obtaining safe, long-term housing through rental assistance, safe temporary shelter through emergency shelter services, and case management services.

As of February 28, 2018, thirty-one (31) adult women received emergency shelter within the Domestic Abuse Shelter and twenty children (20) received emergency shelter. Eight (8) adult women and fourteen (14) children were served through Bridge House, the transitional housing program funded through HAP. Six (6) Domestic Abuse Program clients received Rapid Rehousing. The last emergency shelter admission was on January 1, 2018 to ensure a full thirty days of emergency shelter. The Victim Services Program did not receive any new shelter clients for January 2018, and had one (1) continuing shelter client from the previous month.

Achievements and Improvements in Services: Blair County Community Action Agency has greatly enhanced its' ability to assist families who are homeless or at risk of homelessness. This has been achieved with the addition of several programs that the agency is operating, including the Emergency Solutions Grant (ESG), PA Housing Affordability and Rehabilitation Enhancement (PHARE), and Human Service Block Grant (HSBG) under contract with Blair County and the Regional Veteran Services (RVS) program for Blair County as a subcontractor to Lawrence County Community Action Partnership. The ESG, PHARE, HSBG and, RVS all offer "Homeless Prevention Services" for those at risk of homelessness or "Rapid Re-Housing Services" for the homeless. BCCAA has contracted with Blair County to provide the Employment Transportation program to Blair County residents who are struggling to get to work because they live outside the public transportation routes or its hours of operation.

Unmet Needs and Gaps:

- There is still a significant shortage of shelter beds in Blair County.
- Transportation
- Lack of jobs that provide a living wage.

We evaluate the HAP services provided by Blair County Community Action through the annual reports that they prepare and submit to HUD regarding the HAP/HUD-THP services that they provide. They annually identify a minimum of three benchmarks that they work to achieve. These benchmarks typically include but are not limited to; the percent of persons who exit into permanent housing and the percent of people who become employed.

The information above explains the proposed changes for the Bridge Housing component of the HAP services for the upcoming year.

Case Management

As of July 1, 2018, Blair County Community Action will receive HAP dollars for Case Management. This service runs through all the components of HAP and is designed to provide a series of coordinated activities to determine, with the client, what services are needed to prevent the reoccurrence of homelessness and to coordinate their timely provision by administering agency and community resources. Case Managers assist in identifying needs and reasons for homelessness or near homelessness. The focus is to provide clients with the tools and skills needed to prevent future homeless situations. The many services include budgeting, life skills, job preparation, home management, and referral to drug and alcohol services, if necessary.

Blair County Community Action will serve 980 individuals (projected) in FY 2018/2019.

The assignment of a case management function is used to (1) screen all applications and prevent duplication of services and payments for an individual or their family unit; (2) integrate or coordinate any existing housing assistance programs, such as those funded with Emergency Shelter funds, with the housing Assistance Programs; (3) Establish linkages with the local County Assistance Office to ensure that transitional housing assistance clients do not jeopardize their eligibility for public assistance; (4) provide financial assistance as appropriate.

Unmet Needs and Gaps:

- Transportation
- Limited communication between agencies when consumer receives assistance
- Lack of jobs that provide a living wage.

We will evaluate the Case Management provided by Blair County Community Action by the number of participants and by measuring the change in accessing community resources as a result of program participation. We will also evaluate the Case Management component by determining the housing status change (was the eviction prevented) and/or the number of evictions successfully resolved (did the family move out of homelessness) as reported by Blair County Community Action.

Annual monitoring of the provider, both programmatic and fiscal, is completed.

The proposed change for the Case Management component of the HAP services for the upcoming year is to move these services from Blair Senior Services to Blair County Community Action.

Rental Assistance

As of July 1, 2018, Blair County Community Action will receive HAP dollars for Rental Assistance. This service provides payments for rent, mortgage arrearage for home and trailer owners, rental costs for trailers and trailer lots, security deposits and utilities to prevent and/or end homelessness or near homelessness by maintaining individuals and families in their own residences. The HAP provider works with the landlord to maximize the client's chances for staying in his/her apartment or home, or works with the client to find a more affordable apartment. HAP can also be used to move out of shelter, into an affordable apartment.

Blair County Community Action will serve 250 individuals (projected) in FY 2018/2019. The actual number of individuals served by Blair Senior Services in FY 2017/2018 was 204 (total until March 2018).

Allowable costs, which shall consist of payment for any of the costs listed below, up to a maximum of \$1,500.00 for families with children and \$1,000.00 for adult only households. Allowable costs are; first month's rent; security deposit for rent; utilities (if client is not in Section 8 or subsidized housing; also must state in client's current lease that utility termination is grounds for eviction); emergency shelter; mortgage payments; delinquent rent (cannot be Section 8 or subsidized).

Unmet Needs and Gaps:

- Lack of jobs that provide a living wage.

Residents in Blair County continue to struggle with their ability to pay utilities putting them at risk of being evicted.

We will evaluate the Rental Assistance program provided by Blair County Community Action by measuring the housing status change (was the eviction prevented) and/or the number of evictions successfully resolved (did the family move out of homelessness or near homelessness).

Annual monitoring of the provider, both programmatic and fiscal, is completed.

The proposed change for the Rental Assistance component of the HAP services for the upcoming year is to move these services from Blair Senior Services to Blair County Community Action.

Emergency Shelter

Family Services, Inc. and Blair County Community Action, (as of July 1, 2018) will receive HAP dollars for Emergency Shelter. This service provides refuge and care services to persons who are in immediate need and are homeless with no permanent legal residence of their own, or, who are victims of domestic violence.

Blair County Community Action will serve 250 individuals (projected) in FY 2018/2019. The actual number of individuals served by Blair Senior Services in FY 2017/2018 was 86 (total until March 2018).

Blair County Community Action will use HAP funding to provide assistance to homeless or near homeless individuals for eligible consumers residing within Blair County. The agency's housing programs will provide eligible households with financial assistance, while promoting motivation and individual responsibility to achieve the outcome of affordable housing of their choice. A broad description of the target population would be defined as 18 years of age or older who are homeless, near-homeless or facing utility terminations. Individuals or head of households under the age of 18 would be eligible when validated as emancipated through the Department of Human Services.

Family Services Inc. provides services for homeless families and individuals in Blair County. Homeless or near homeless individuals are referred by agencies, churches and self-referrals. The agency strives to affect positive change by providing a clean, safe, and supportive environment while assisting clients in obtaining permanent housing and other services necessary to achieve a more independent lifestyle. On site case management is provided on a daily basis in order to help clients move toward self-sufficiency more expeditiously. The Family Shelter is accessible 24 hours a day. The Family Shelter provides an integral part of the continuum of care in Blair County by providing the only emergency shelter in Blair County that exclusively addressed the needs of homeless families. The presence of the Family Shelter decreases the probability of homeless residents living on the streets.

Achievements and Improvements in Services: Family Service's vision over the next three years is to have a 35 bed Family Shelter. The R.K. Agarwal M.D. And Family Teen Center and Shelter moved to a 9 bed handicapped accessible facility in January of 2017.

Unmet Needs and Gaps:

- There is still a significant shortage of shelter beds in Blair County.
- Transportation
- Lack of jobs that provide a living wage.
- Lack of permanent, affordable housing resulting in longer lengths of stay in the shelter decreasing the number of individuals served. The current housing situation lends to 2 year (or longer) waiting lists for subsidized housing in the Blair County area. These programs have stopped accepting applications in the latter part of the fiscal year, which is a trend we have seen in the past few years.
- Timely referral options for mental health treatment, particularly for shelter guests who are in need of MH prescriptions. Most waiting lists to see a mental health doctor are at least 6+ weeks long, often prolonging a sense of hopelessness and frequent mental health crisis admissions.

Residents in Blair County continue to struggle with their ability to pay utilities putting them at risk of being evicted.

We do evaluate the efficacy of each HAP service that we provide. The quality assurance program will be entering the fifth year, and we are able to evaluate the services provided.

We also evaluate the efficacy of the Family Shelter program through Family Services, Inc. We review outcome measurements based on increased safety and self-sufficiency of those served in the Family Shelter.

The proposed change for the Emergency Shelter component of the HAP services for the upcoming year is to move these services from Blair Senior Services to Blair County Community Action.

Other Housing Supports

We do not currently use Block Grant funding for this category. Our HAP providers use other funding streams to offer several housing support services to their HAP clients.

Homeless Management Information Systems

Blair Senior Services currently tracks the number of homeless or near homeless individuals who received emergency shelter and were then transitioned into stable housing. For FY 2017/2018, 86 clients received emergency shelter and 41 of the 86 (47%) were transitioned into stable housing.

Blair Senior Services agreed to track the known destination for clients upon exit or verified connection to permanent housing and also the increased participation by homeless individuals in mainstream systems. For FY 2017/2018, the known destinations, by zip code, for clients are as follows:

- Zip Code 16601 – 20 consumers
- Zip Code 16602 - 19 consumers
- Zip Code 16617 - 0 consumers
- Zip Code 16635 - 0 consumers
- Zip Code 16648 - 0 consumers
- Zip Code 16673 - 0 consumer
- Zip Code 16637 - 0 consumers
- Zip Code 16686 - 2 consumers

Family Services Inc. currently tracks whether a client went to a new home or returned to previous residence upon exit from the Domestic Abuse Shelter. As of February 28, 2018, out of 46 victims (adult women) served within the Domestic Abuse Shelter, 39 of the women obtained permanent, safe housing, 4 returned to their abuser and 3 left the shelter without notifying Family Services, Inc. of their plans.

The staff of the Family Shelter tracks the percentage of clients who are still in permanent housing at 6 week intervals. As of February 2018, the percentage was 78%.

The staff of the Family Shelter also tracks the number of people who are turned away due to lack of space at the shelter. From July 1, 2017 through February 28, 2018, 204 individuals had to be turned away because the shelter was full.

Family Services Inc. has also begun to track the increased participation by homeless individuals in mainstream systems. During the 2016/2017 fiscal year, 190 referrals were made to mainstream systems and 182 (95%) had followed through and participated.

Blair County Community Action Agency reported the following data on the known destination of clients who stayed longer than 90 days and exited their homeless programs. In their HUD funded Rapid Re-Housing 1 (formerly called Transitional Housing) Program (RRH1) during the year between 10/1/2016 thru 9/30/2017 they had 56 (89%) exit into permanent housing. In their HUD funded Rapid Re-Housing 2 (formerly called Journey) Program (RRH2) during the year between 10/1/2016 thru 9/30/2017 they had 28 participants exit the program. 21 (75%) exited into permanent housing, 5 (18%) exited to an unknown destination, and 2 (7%) returned to homelessness. In their HUD funded Rapid Re-Housing Program (RRH) during the year between 10/1/2016 thru 9/30/2017 they served 68 clients and 62 (91%) exited the program into permanent housing.

Blair County Community Action agency also tracks participation in mainstream benefits but not the increase in usage. In their RRH1 program 75% were receiving 1 or more mainstream benefits (in the case of this program the benefits included Medicaid and food stamps). In their SSO program 68.5% were receiving 1 or more mainstream benefits (in the case of this program the benefits included Medicaid, food stamps, Medicare, VA Medical Benefits and Section 8 housing assistance). In their RRH2 program 55% were receiving 1 or more mainstream benefits (in the case of this program the benefits included Medicaid, food stamps, Medicare, VA Medical Benefits and Section 8 housing assistance). In their RRH program 77.8% were receiving 1 or more mainstream benefits (in the case of this program the benefits included Medicaid, food stamps, Medicare, VA Medical Benefits and Section 8 housing assistance).

Blair County is a member of the Eastern Pennsylvania Continuum of Care (CoC PA-507). This CoC is a consortium of 33 counties in the eastern part of the State. All homeless programs funded through the Homeless Emergency Assistance and Rapid Transition to Housing (HEARTH) Program are under the purview of the CoC. This includes the Emergency Solutions Grant (ESG) and the CoC Programs that in the past were referred to as the McKinney-Vento Homeless Programs funded by HUD.

As a member county of the CoC, all of the HEARTH funded homeless programs (ESG and CoC Programs) in the County are required to enter data into the Homeless Management Information System (HMIS) that has been developed by and is operated by the Pennsylvania Department of Community and Economic Development (DCED). The DCED HMIS was designed to capture all of the data elements that are required by HUD for these programs and is made available for all of the member counties of the CoC.

The Blair County organizations that are currently entering data into the HMIS and/or utilizing the data for reporting includes; the City of Altoona, Blair County Planning Commission, Blair County Community Action Agency, American Rescue Workers of Hollidaysburg, Home Nursing Agency, Family Services of Blair County and Blair Senior Services. These organizations are required to participate in the use of the HMIS because they are receiving HEARTH Program funding. They have been entering data into the HMIS for several years. The CoC encourages all other organizations that operate homeless programs to utilize the HMIS as well regardless of the source of their funding.

2018 Blair County Continuum of Care Services

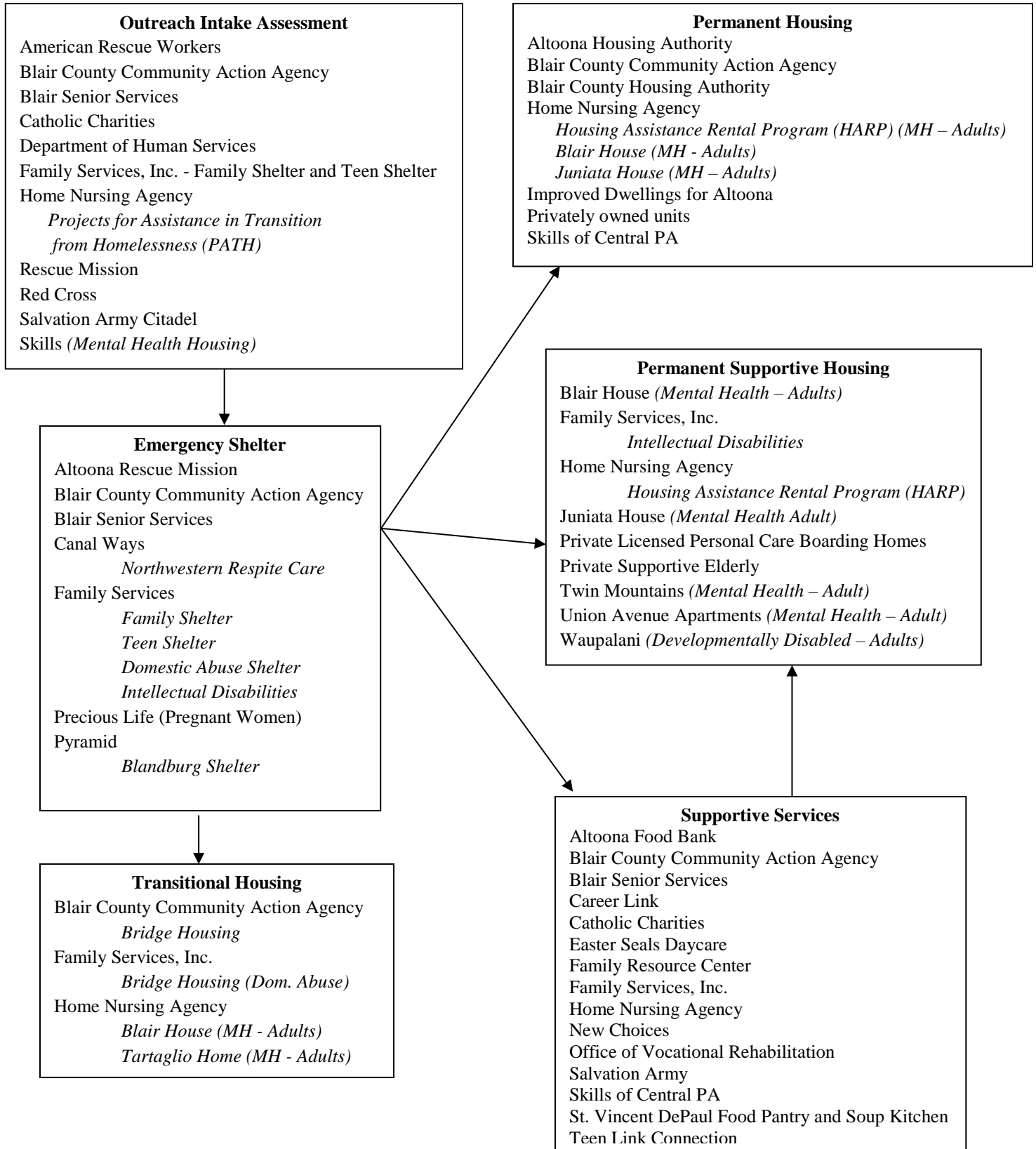

Substance Use Disorder Services

1) Waiting List Information

	# of Individuals	Wait Time (days)**
Detoxification Services	0	
Non-Hospital Rehab Services	0	
Medication Assisted Treatment	0	
Halfway House Services	34 male 3 female	6-8 weeks
Partial Hospitalization	0	
Outpatient	5*	3 weeks+*

*We have lost our local capacity for a network provider for BC/BS. One provider is completely full and the other 2 providers lost their paneled staff member. Both providers are working to hire and get new paneled staff. Individuals can receive care at locations outside of the county but time and transportation becomes an issue.

**Use average weekly wait time

2) Overdose Survivors' Data

Strategy: SCA Model

SCA has a functioning 24/7 warm hand off with the inpatient psychiatric unit inpatient social worker units of all three hospitals, UPMC, Nason and Tyrone Hospital. The SCA has improved the referral process for drug and alcohol treatment with each of these hospitals. Overdose surveyors are not only being intervened upon at the Emergency Department (ED) but some are admitted to the medical floor and inpatient psychiatric unit. The SCA has been providing mobile screening and assessment services. SCA uses a combination of CRSs and Case Management to support these services.

July 1, 2016 - June 30, 2017			
# of Overdose Survivors	# Referred to Treatment	# Refused Treatment	# of Deaths from Overdoses *Calendar year 2016
274	274	10	43
July 1, 2017- Present			
# of Overdose Survivors	# Referred to Treatment	# Refused Treatment	# of Deaths from Overdoses *Calendar year 2017
196	196	4	52

3) Levels of Care (LOC)

LOC	# of Providers	# of Providers Located In-County	Special Population Services**
Inpatient Hospital Detox	1	0	
Inpatient Hospital Rehab	1	0	
Inpatient Non-Hospital Detox	11	2	Adult/Adolescent/IDU
Inpatient Non-Hospital Rehab	19	2	Adult/Adolescent/IDU/Co-Occurring
Partial Hospitalization	3	3	Adult/Adolescent/IDU
Intensive Outpatient	5	5	
Outpatient	7	8	
Halfway House	11	3	

4) Treatment Services Needed in County

Priorities and Strategies:

Priority 1: Build capacity to treat SUD/ODU and promote recovery in Blair County.

Strategy: Increase access to and engagement of services throughout the continuum of care, including prevention programs, appropriate treatment at all levels of care (including MAT resources), and maintenance/sustainability of recovery resources.

- Existing Planning and Implementation planning:
 - CRS embedding into the ED at UPMC Altoona
 - Expansion of CRS
 - Dosing of Suboxone at time of overdose survivor presenting in the ED
 - Implementation of the McGee Recovery Model in the Blair County Health Beginnings Pregnancy Care clinic-(MAT expansion –subutex initiation by physicians)
 - Expanding Physical Health MAT providers
 - Enhancement of clinical practices in drug and alcohol providers and OTPs.
 - Incorporating Certified Behavioral Health Homes in OTPs

Priority 2: Implement a 24/7 warm handoff throughout Blair County.

Strategy: Expand existing warm handoffs to include Frist Responders (EMS, Fire, and Police), and the criminal justice system to connect overdose survivors to treatment.

- Existing Warm Handoff Initiatives:
 - Emergency Departments
 - Inpatient Psych Units
 - Physical Health Units
 - Adult Probation and Parole
 - 24/7 Telephonic hotline

Priority 3: Increase community awareness and reduce stigma.

Strategy: Launch a public awareness campaign to increase awareness for all individuals in Blair County.

- Existing:
 - Rise for Recovery advocacy movement
 - Implementing family recovery education series
 - Recovery Panel presentation at community events/conferences

5) Access to and Use of Narcan in County

The SCA coordinated with Southern Alleghenies Emergency Management System at the time the PCCD grant was made available to provide NARCAN. SAEMS is the central coordinating entity for Blair County. Up to this point, the SCA had met individually with all Chiefs in the County who were not carrying NARCAN. Many barriers exist for the smaller departments as well as stigma. In addition, the SCA has partnered to provide training at two EMS conferences held in November 2017 and April 2018.

Currently, 5 police departments (Altoona/Logan/Tyrone/Bellwood/Hollidaysburg) and the Altoona City Fire Department carry Narcan. In addition, the SCA has educated the County Adult Probation, Juvenile Probation and Sherriff Department. We worked through the county solicitor to approve the policies for these departments to carry NARCAN. All three are approved to carry. We have met with the prison but are still discussing the process for this partner. The SCA will be implementing in the next 30 days a process to provide NARCAN at the time of a level of care assessment. The SCA provides overdose education 2 times during the month to the general community. We also provide overdose prevention training to other partners upon request. The SCA is engage in the local Overdose Prevention Task Force. The following are 2 priorities identified by this group:

Priority 1: Increase access and utilization of naloxone to save lives.

Strategy: Ensure all persons at high risk of overdose have access to naloxone, including trainings on administration and accompanied rescue/medical techniques (ex. rescue breathing).

Priority 2: Ensure that all residents of Blair County are well-informed on signs of a Substance Use Disorder (SUD)/Opioid Use Disorder (OUD), overdose, treatment and recovery options, and medication drop off boxes that are available in the community.

Strategy: Increase addiction and overdose education for professionals who are in contact with individuals at high risk for overdose and individuals with a SUD/OUD and their families.

6) ASAM Training

The BHMCO is taking the lead on the training for ASAM. They have scheduled 2 trainings in May which are full. They have scheduled another training in August 2018. The following are estimates of the provider network needs. We will be discussing the need to offer more training for existing staff but then also any new staff who are hired and new to the field.

	# of Professionals to be Trained	# of Professionals Already Trained
SCA	3	9
Provider Network	72	128

At this point Community Care is going to continue to assess the need for additional trainings after the next round is completed. There is a good possibility that more will need to be scheduled and we will then be looking at doing regional trainings at that point. One of the issues is that as each training rolls out numbers continue to change. Community Care is going to do our best to stay on top of the need and offer whatever is needed.

Human Services and Supports/Human Services Development Fund

Services to Be Provided

Adult Services

Program Name: Counseling Services

Description of Services: The target group to be served by Family Services, Inc. consists of individuals, families and couples. Counseling services are provided by master's trained clinicians who are licensed and/or certified to practice in Pennsylvania. The staff also coordinates and clinically facilitates Men Helping Men, a group program for men who are abusive towards their partners and their children directly or indirectly.

Family Services, Inc. provides a diverse range of counseling services for low income persons of all ages. However, the counseling services funded through HSDF are provided only to those who are between the ages of 18 and 59 years of age or under. The primary purpose and need of the counseling programs are to provide counseling services that assist people in solving problems that are interfering with their healthy development and functioning. The expected outcome is that people will learn the skills necessary to solve their problems in the future. This outcome prepares the clients to move toward economic and emotional self-sufficiency and moves clients to a more optimal level of functioning and wellbeing. It helps families to become stronger and improves life skill development.

Service Category: Counseling

Aging Services

Program Name: Care Management Services

Description of Services: All persons requesting or receiving Care Management services are assigned to a Care Manager. An initial visit is scheduled with the consumer and the family, if requested. This initial visit is conducted within 7 days of the receipt of the referral. During the initial visit, the consumer is assessed for level of care using the Level of Care Determination (LCD). The consumer is also assessed for all care needs, using the Needs Assessment Tool (NAT). The information is then used to create a care plan to meet the consumer's needs. The Care Manager uses the information gained in the assessments to assess a Functional Needs Measurement score for the consumer. This score determines the consumer's position on a waiting list for services, should a waiting list exist. Regardless of a consumer being on a waiting list, Care Management services are still provided. The Long Term Living Program Supervisor reviews all completed assessments and care plans. Consumers approved to begin services are offered a choice of providers and the services are initiated. A follow-up call is made to the consumer two weeks following the initiation of services. Consumers are reassessed annually or more frequently if needed, to assess for any changes in need. The Care manager is available to the consumer for assistance with provider issues, scheduling, change in services or amounts of service, assistance with applications and forms completion, and as a source of information and referral. Those consumers who remain on the waiting list receive a call every 6 months from the Care Manager to assess the consumer's desire to stay on the waiting list. The Care Manager is available for assistance with applications, forms completion and as a source of information and referral.

Service Category: Care Management

Children and Youth Services

We do not currently use Block Grant funding for this category.

Generic Services

Program Name: Information and Referral

Description of Services: The target group to be served by CONTACT Altoona includes individuals or agencies in need of referral assistance for health and human service in the Blair County area. It is a major challenge for people to learn about and connect with services that are available. Too often people looking for help do not know where to begin. Locating such basic resources as food, shelter, employment or health care may mean calling dozens of phone numbers and struggling through a maze of agencies to make the right connection. This growing need of our population for human services increases the need to effectively and efficiently connect people with the broadest possible range of community resources. CONTACT Altoona's role in this provision of information and referral services is Blair County's connection to PA 2-1-1.

Many people have a myriad of problems when they call. CONTACT volunteers listen for the unspoken, as well as the spoken, indicators while assisting the caller in determining the most appropriate source of help. CONTACT attempts to address each of the callers' needs and/or successfully refer the caller to the proper agency for help. CONTACT volunteers are trained to listen reflectively to persons of all ages and socio-economic backgrounds. There are two types of information and referral calls received by CONTACT Altoona: (1) persons knowing what the problem is and seeking a referral to solve their problem or persons seeking services from a certain agency; and (2) a caller may need a referral to another agency for help in solving his/her problems. When it becomes apparent that a referral is appropriate, the telephone workers may suggest a referral. In many instances it is advisable to assist callers in how to approach an agency when calling. Good information and referral services will assist callers in how to present their problems so they will not be denied service before reaching the appropriate person.

CONTACT Altoona is one of the founding partners in the PA 2-1-1 initiative. CONTACT Altoona is a satellite call center for the statewide PA 2-1-1 system, linking individuals in need to essential health and human services. CONTACT Altoona provides direct access to PA 2-1-1 services through the website (<https://pa211central.info/>) and provision of 24-hour telephone services to directly connect individuals to needed services. Callers who dial 2-1-1 speak with a call specialist who has access to the online, comprehensive database (Vision Link) utilized by all PA 2-1-1 call centers. Through conversation with callers, the call specialist is able to determine the need or needs of the caller and search the database for agencies and organizations in the caller's specific area that provide the needed services. Searches are done by zip code and county. Call specialist will search the world-wide web to find available information if the requested services are not contained in the database. PA 2-1-1 is able to refer callers, both individuals and agencies, who may not know what services other agencies provide to the correct resources. Our referrals also keep callers from becoming frustrated by calling multiple agencies to find the right fit. CONTACT Altoona continually updates and maintains the PA 2-1-1 Database (<https://pa211.communityos.org/cms/>). The PA 2-1-1 Database provides the most accurate and updated resources for information and referrals in response to health and human service needs. The PA 2-1-1 Database is accessible 24 hours a day and is available to all members of the community. CONTACT Altoona's provision of information and referral services is necessary and vital in the implementation of 2-1-1.

Service Category: Centralized Information and Referral

Population Served: CONTACT Altoona's Information and Referral Program serves all populations.

Specialized Services

Program Name: Big Brothers/Big Sisters

Description of Services: Big Brothers/Big Sisters of Blair County, Inc. an affiliate of Big Brothers/Big Sisters of America, Inc. provides youth mentoring services designed to help a child develop a positive relationship with a caring adult, who serves as a role model and will see the child on a regular basis. The Agency provides youth development activities and programs. These programs are conducted on a monthly basis, are age appropriate, and utilize Search Institutes 40 Developmental Assets as a base for presenting a wide variety of youth development activities. The agency has a core group of children and youth who continually participate monthly, providing a greater impact and learning. Big Brothers/Big Sisters of Blair County, Inc. has expanded services to include site-based/school based mentoring known as SMART programming. Two current High School Big mentoring programs have proven effective over the past several years. These programs are designed in partnership with school personnel to meet the needs of school identified students.

Program Name: Teen Link Connection

Description of Services: Child Advocates of Blair County, through their Teen Link Connection program, provides intervention services, prevention services, case management, and referral services to pregnant and parenting teens and their families. Although other programs are available to support pregnant and parenting teens, these programs have restrictions with who they can serve. One program requires the adolescent to be enrolled in school, while another program requires the adolescent to be on their first pregnancy and request services by a specific number of weeks within the pregnancy. Teen Link Connection is the only program in Blair County that provides services to pregnant and parenting teens that have dropped out or recently graduated from school. Teen Link Connection is also a program that can provide services to adolescents even if they did not request services while they were pregnant. We currently do not have any pregnant or parenting teens on our case load due to a lack of clients fitting the requirements, however we are still very active in offering parent education and referral services. Teen Link Connection also continues to provide education and support services to the community in an effort to prevent teen pregnancy and to raise awareness of the problems associated with teen pregnancy. This is done through outreach efforts such as Teen Power Day, the Teen Pregnancy Prevention Team, CHOICES, and the All STARS program. The 15th annual Teen Power Day will be held on May 8, 2018 on the Penn State Altoona Campus. Students from all surrounding school districts have been invited. We will continue with previous speakers who will present many topics such as: Healthy Relationships, Bullying, Teen Pregnancy and Parenting, Facts on STDs, Dangers of Nicotine and Alcohol Addiction, as well as Cannabis, and Vaping, Choices and Consequences. This year we have added a special speaker, a mother who lost both of her sons to drug overdoses on the same day. She is sharing her story with the hope of making a difference in the life of another.

At this point, the All Stars program has served 14 students in 7th – 9th grade for the 2017 fall portion of this school year. We have just begun the second session of All Stars for the spring semester with 10 students. We expect to end the year with 25 to 30 students.

Program Name: Reassurance Program

Description of Services: CONTACT Altoona provides a Reassurance Program, the only provider of this service in the Blair County community. CONTACT Altoona's Reassurance program provides personal contact by telephone to check on an individual's wellbeing. The purpose of the daily reassurance calls is multi-fold. Daily calls are made to make sure that the person is in reasonable good health and able to answer the telephone; to share a few minutes in a friendly chat to let the person know that someone cares; make sure they are getting adequate nutrition; and if applicable, remind the person to take medicines. This program seeks to be a safety net to ensure the health and safety of our aging population. When the Reassurance call is not answered, help is sent to the individual.

Interagency Coordination

The Blair County Department of Social Services will use Human Services Development Fund dollars for Interagency Coordination to help fund a coordinated county-wide Needs Assessment. The purpose of the comprehensive assessment is to identify community assets, identify targeted needs and develop an action plan to fill those needs. However, the ultimate goal is to improve the lives of all people living in Blair County. These dollars are also used to build partnerships through collaboration with other agencies and organizations. We work toward solving problems that exist within our community and to improve the effectiveness of the service delivery system. Our goals are to develop a better knowledge of existing agencies and services, provide education to others about community resources, and increase and promote the quality of human services in the community. Interagency Coordination expenditures include expenses incurred for staff to attend the following Human Services Committees or Councils which serve in an advisory capacity: Blair County Health & Welfare Council, Blair County Local Housing Options Team (LHOT), Blair County Healthy Community Partnership, Blair County Leadership Coalition, Blair County Needs Net, Blair County Fuel Bank, and the Heat & Utilities Task Force. These collaborations are vital for the coordination of not only state funded programs but the link to private partnerships such as faith based organizations, United Way, and local leaders. Expenditures also include staff coordination with state committees such as Long Term Care, Department of Education and PACHSA. PACHSA dues are not included in the expenditures for Interagency Coordination.

Appendix “C-1”
Blair County Human Services Block Grant
Proposed Budget and Individuals Served

County: BLAIR	1. ESTIMATED INDIVIDUALS SERVED	2. HSBG ALLOCATION (STATE & FEDERAL)	3. HSBG PLANNED EXPENDITURES (STATE & FEDERAL)	4. NON-BLOCK GRANT EXPENDITURES	5. COUNTY MATCH	6. OTHER PLANNED EXPENDITURES
--------------------------	--	---	---	--	--------------------------------	--

MENTAL HEALTH SERVICES

ACT and CTT	0					
Administrative Management	1,891		388,243		9,314	
Administrator's Office			410,697		42,645	
Adult Developmental Training	0					
Children's Evidence-Based Practices	0					
Children's Psychosocial Rehabilitation	0					
Community Employment	59		191,132		19,113	
Community Residential Services	55		388,678		31,446	
Community Services	0		31,500		3,500	
Consumer-Driven Services	41		117,433		8,505	
Emergency Services	781		404,232		40,877	
Facility Based Vocational Rehabilitation	14		138,151		15,350	
Family Based Mental Health Services	6		30,000			
Family Support Services	10		108,790		14,199	
Housing Support Services	135		85,189	47,087	9,959	
Mental Health Crisis Intervention	1,126		290,000			
Other	0					
Outpatient	1,177		493,348		7,359	
Partial Hospitalization	29		62,000			
Peer Support Services	0					
Psychiatric Inpatient Hospitalization	0					
Psychiatric Rehabilitation	50		70,000			
Social Rehabilitation Services	182		126,688		12,312	
Targeted Case Management	252		191,200			
Transitional and Community Integration	330		287,213		8,728	

TOTAL MENTAL HEALTH SERVICES	6,138	\$3,814,494	\$3,814,494	\$47,087	\$223,307	\$0
-------------------------------------	-------	-------------	-------------	----------	-----------	-----

County: BLAIR	1. ESTIMATED INDIVIDUALS SERVED	2. HSBG ALLOCATION (STATE & FEDERAL)	3. HSBG PLANNED EXPENDITURES (STATE & FEDERAL)	4. NON-BLOCK GRANT EXPENDITURES	5. COUNTY MATCH	6. OTHER PLANNED EXPENDITURES
--------------------------------	--	---	---	--	--------------------------------------	--

INTELLECTUAL DISABILITIES SERVICES

Administrator's Office			1,014,711	23,444	4,605	
Case Management	955		41,400	2,576,422	4,600	
Community-Based Services	806		100,412	27,631,122	9,535	
Community Residential Services	182			21,794,410		
Other	0		157,500		17,500	

TOTAL INTELLECTUAL DISABILITIES SERVICES	1,943	\$1,314,023	\$ 1,314,023	\$52,025,398	\$36,240	\$0
---	-------	-------------	--------------	--------------	----------	-----

HOMELESS ASSISTANCE SERVICES

Bridge Housing	90		31,897			
Case Management	980		98,120			
Rental Assistance	550		66,545			
Emergency Shelter	440		40,155			
Other Housing Supports	0		0			
Administration			26,300			

TOTAL HOMELESS ASSISTANCE SERVICES	2,060	\$263,017	\$263,017	\$0	\$0	\$0
---	-------	-----------	-----------	-----	-----	-----

County: BLAIR	1. ESTIMATED INDIVIDUALS SERVED	2. HSBG ALLOCATION (STATE & FEDERAL)	3. HSBG PLANNED EXPENDITURES (STATE & FEDERAL)	4. NON-BLOCK GRANT EXPENDITURES	5. COUNTY MATCH	6. OTHER PLANNED EXPENDITURES
--------------------------------	--	---	---	--	--------------------------------------	--

SUBSTANCE USE DISORDER SERVICES

Case/Care Management	1,200		244,590			
Inpatient Hospital	1		3,000			
Inpatient Non-Hospital	20		45,000			
Medication Assisted Therapy	30		40,000			
Other Intervention	1,500		10,000			
Outpatient/Intensive Outpatient	20		50,000			
Partial Hospitalization	25		45,000			
Prevention	500		7,000			
Recovery Support Services	250		75,000			
Administration			57,732			

TOTAL SUBSTANCE USE DISORDER SERVICES	3,546	\$577,322	\$577,322	\$0	\$0	\$0
--	-------	-----------	-----------	-----	-----	-----

HUMAN SERVICES DEVELOPMENT FUND

Adult Services	50		11,325			
Aging Services	49		2,250			
Children and Youth Services	0		0			
Generic Services	2,800		2,425			
Specialized Services	352		19,000			
Interagency Coordination			90,127			
Administration			13,903			

TOTAL HUMAN SERVICES DEVELOPMENT FUND	3,251	\$139,030	\$139,030	\$0	\$0	\$0
--	-------	-----------	-----------	-----	-----	-----

GRAND TOTAL	16,938	\$6,107,886	\$6,107,886	\$52,072,485	\$259,547	\$0
--------------------	--------	-------------	-------------	--------------	-----------	-----

Mental Health in Blair County

Access Center for Mental Health Services 814-889-2289

UPMC COMMUNITY CRISIS CENTER

814-889-2141

BLAIR DRUG AND ALCOHOL PARTNERSHIPS

814-381-0921

FOR HEALTH & HUMAN SERVICE NEEDS CALL 211

It's OK to talk about mental health.

Get help if you need it.

Help is available and effective.

If you know someone in need, help is available.

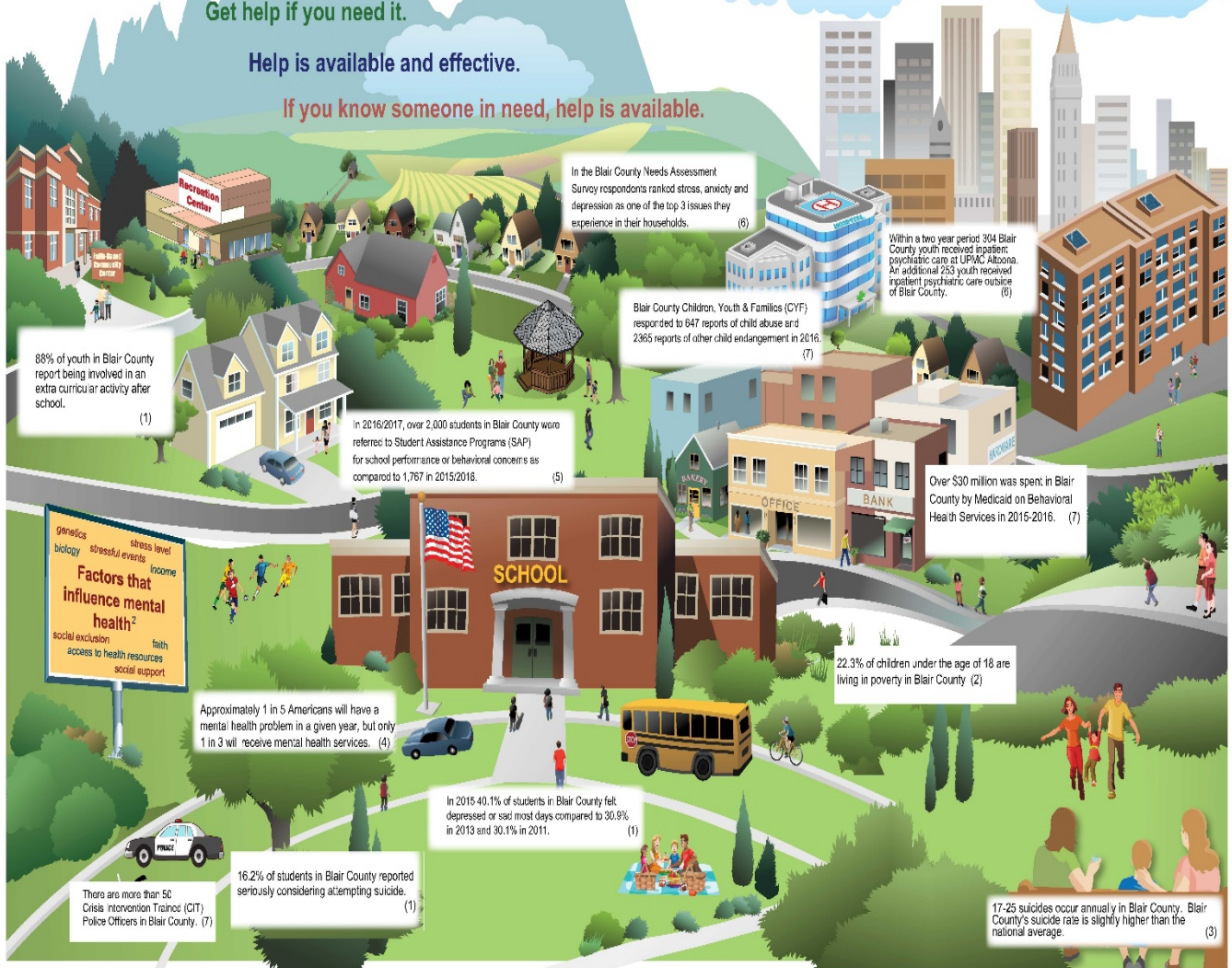

88% of youth in Blair County report being involved in an extra-curricular activity after school. (1)

In 2016/2017, over 2,000 students in Blair County were referred to Student Assistance Programs (SAP) for school performance or behavioral concerns as compared to 1,767 in 2015/2016. (5)

In the Blair County Needs Assessment Survey respondents ranked stress, anxiety and depression as one of the top 3 issues they experience in their households. (6)

Blair County Children, Youth & Families (CYF) responded to 647 reports of child abuse and 2365 reports of other child endangerment in 2016. (7)

Within a two year period 304 Blair County youth received inpatient psychiatric care at UPMC Altoona. An additional 253 youth received inpatient psychiatric care outside of Blair County. (6)

Over \$30 million was spent in Blair County by Medicaid on Behavioral Health Services in 2015-2016. (7)

genetics stress level biology stressful events income
Factors that influence mental health²
social exclusion faith access to health resources social support

Approximately 1 in 5 Americans will have a mental health problem in a given year, but only 1 in 3 will receive mental health services. (4)

In 2015 40.1% of students in Blair County felt depressed or sad most days compared to 30.9% in 2013 and 30.1% in 2011. (1)

22.3% of children under the age of 18 are living in poverty in Blair County (2)

There are more than 50 Crisis Intervention Training (CIT) Police Officers in Blair County. (7)

16.2% of students in Blair County reported seriously considering attempting suicide. (1)

17-25 suicides occur annually in Blair County. Blair County's suicide rate is slightly higher than the national average. (3)

(1) Pennsylvania Youth Survey (PAYS 2015) <http://www.pccd.pa.gov/Juvenile-Justice/Documents/PAYS/2015%20County%20Reports/Blair%20County%20Profile%20Report.pdf>
 (2) United States Census Bureau (2015)
 (3) American Foundation of Suicide Prevention <https://afsp.org/about-suicide/prevention/state-fact-sheets/#Pennsylvania>
 (4) Community Conversations About Mental Health, Information Brief - SAMHSA <https://www.samhsa.gov>
 (5) Pennsylvania Student Assistance Report <https://www.sateschools.state.pa.us>
 (6) Healthy Blair County Coalition www.healthylaircountycoalition.org
 (7) Blair County Data



<http://www.healthylaircountycoalition.org/>

Appendix "D"
UPMC Altoona Memorandum of Understanding

MEMORANDUM OF UNDERSTANDING

Between

UPMC Altoona

And

The Blair County Department of Social Services

RE: Provision of Short-Term Inpatient Psychiatric Care for Residents of Blair County

A. UPMC Altoona agrees to:

1. Provide short-term inpatient psychiatric diagnosis and treatment for all residents of Blair County who are evaluated as requiring this service, regardless of ability to pay.
2. Accept and provide evaluation and treatment for both voluntary and involuntary commitments.
3. Cooperate with the Program Office in all aspects of the involuntary commitment and hearing process.
4. Coordinate with the Base Service Unit and all mental health and other referral agencies in the development of a comprehensive treatment and aftercare plan for each patient admitted.
5. Provide data as requested by the County on patients served.
6. Seek reimbursement from the patient, family, if applicable, and all third party carriers in accordance with the liability regulations of the Department of Human Services. The County shall not be billed for nor will they reimburse for any short-term inpatient care for Blair County residents.

B. The County agrees that the Administrator for Blair County Department of Social Services agrees to:

1. Designate UPMC Altoona as the primary facility to evaluate and treat involuntary commitments of Blair County residents.

2. Coordinate the involuntary admission and hearing process, providing staff assistance as indicated.
 3. Provide staff assistance as needed in the transfer process of patients from UPMC Altoona to all State operated psychiatric facilities.
 4. Coordinate quarterly review meetings between UPMC and County on regrading cases, policies, procedures and other item that affect the overall operations.
- C. Terms of the Agreement - This agreement shall be effective as of July 1, 2018 and remain in effect until June 30, 2019.
1. This agreement may be amended by written consent of both parties, and all amendments shall be attached to this agreement.
 2. Either party to this agreement may give the other party 60 days written notice of their intention to terminate the agreement.

**Blair County
Department of Social Services**

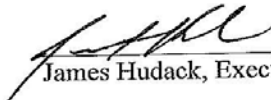

James Hudack, Executive Director

4/19/18
Date

UPMC Altoona

Mark Chuff, Executive Director
Behavioral Health Services

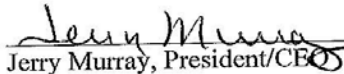
4/19/18
Date

Jerry Murray, President/CEO

4/19/18
Date